

SAN JOSÉ/SANTA CLARA TREATMENT PLANT ADVISORY COMMITTEE

SAM LICCARDO, CHAIR
DEBI DAVIS, VICE CHAIR
LAN DIEP, MEMBER
DAVID SYKES, MEMBER
DEV DAVIS, MEMBER

CARMEN MONTANO, MEMBER
KATHY WATANABE, MEMBER
PAUL RESNIKOFF, MEMBER
JOHN GATTO, MEMBER

SPECIAL MEETING AGENDA/TPAC

4:00 p.m.

May 7, 2020

Virtual

*** COVID-19 NOTICE ***

Consistent with the California Governor's Executive Order No. N-29-20, Resolution No. 79450 from the City of San José and the Santa Clara County Health Officer's March 16, 2020 Shelter in Place Order, the Treatment Plant Advisory Committee (TPAC) meeting will not be physically open to the public and Committee Members and staff will be teleconferencing from remote locations.

How to submit written Public Comment before the TPAC Meeting:

By email to ESDWebinar@sanjoseca.gov by 12:00 p.m. the day of the meeting. Those emails will be considered as if they were part of the meeting. Please identify the Agenda Item Number in the subject line of your email.

How to submit written Public Comment during the TPAC Meeting:

Email during the meeting to ESDWebinar@sanjoseca.gov, identifying the Agenda Item Number in the email subject line. Comments received will be included as a part of the meeting record but will not be read aloud during the meeting.

How to provide Spoken Public Comment during the TPAC Meeting:

By phone **(888) 475-4499** Meeting ID: **925 2304 7335** Click *9 to raise a hand to speak.

By online **<https://sanjoseca.zoom.us/j/92523047335>**

- a. Use a current, up-to-date browser: Chrome 30+, Firefox 27+, Microsoft Edge 12+, Safari 7+. Certain functionality may be disabled in older browsers including Internet Explorer. Mute all other audio before speaking. Using multiple devices can cause an audio feedback.
- b. Enter an email address and name. The name will be visible online and will be used to notify you that it is your turn to speak.
- c. When the Chair calls for the item on which you wish to speak, click on "raise hand." Speakers will be notified shortly before they are called to speak.
- d. When called, please limit your remarks to the time limit allotted.

1. **ROLL CALL**

2. **APPROVAL OF MINUTES**

1. February 13, 2020

3. **UNFINISHED BUSINESS/REQUEST FOR DEFERRALS**

4. **DIRECTOR'S REPORT**

- A. Director's Report (verbal)
- Monthly Progress Report (January, February)

5. **AGREEMENTS/ACTION ITEMS**

- A. Second Amendment to the Master Consultant Agreement with Cornerstone Earth Group for Environmental Support Services

Staff Recommendation:

Approve the Second Amendment to the Master Consultant Agreement with Cornerstone Earth Group, Inc. (Master Agreement) for environmental consulting services, increasing the amount of compensation by \$500,000, for a total agreement not to exceed \$1,500,000.

This item is scheduled to be heard by City Council on May 12, 2020.

- B. Report on Bids and Award of Contract for 9115 – Administration Building Roof Replacement Project at the San José – Santa Clara Regional Wastewater Facility

Staff Recommendation:

- a) Report on bids and award of a construction contract for 9115-Administration Building Roof Replacement Project to the low bidder, Stronger Building Services, in the amount of \$590,000, and
- b) Approve a 20 percent construction contingency in the amount of \$118,000.

This item is scheduled to be heard by City Council on May 19, 2020.

- C. Report on Bids and Award of Construction Contract for 9394 – Legacy Lagoons Cleanup Phase 1 Project at the San José – Santa Clara Regional Wastewater Facility Project

Staff Recommendation:

- (a) Adopt a resolution adopting an Addendum to the Environmental Impact Report for the San José – Santa Clara Water Pollution Control Plant Master Plan Project in accordance with the California Environmental Quality Act (CEQA), as amended, and adopting a related Mitigation Monitoring and Reporting Program.
- (b) Report on bids and award of contract for the 9394 – Legacy Lagoons Cleanup Phase 1 Project to the low bidder, Pipe and Plant Solutions, Inc. in the amount of \$4,901,796, and approval of a 15 percent contingency in the amount of \$732,270.
- (c) Adopt the following 2019-2020 Appropriation Ordinance Amendments in the San José – Santa Clara Treatment Plant Capital Fund:
 - 1. Decrease the Support Building Improvements appropriation to the Environmental Services Department by \$8,037,066; and
 - 2. Establish the Legacy Lagoons Biosolids Remediation appropriation to the Environmental Services Department in the amount of \$8,037,066.

This item is scheduled to be heard by the City Council on May 12, 2020.

6. OTHER BUSINESS/CORRESPONDENCE

- A. Information Memo: Pond A-18 Negotiations
- B. Letter dated April 23, 2020 from San Francisco Bay Regional Water Quality Control Board to San José City Manager Dave Sykes and Santa Clara City Manager, Deanna J. Santana
- C. Letter dated April 3, 2020 from Valley Water, US. Corps of Engineers and California State Coastal Conservancy to San Francisco Bay Regional Water Quality Control Board
- D. Letter to IBEW and TPAC regarding Coronavirus Safety at RWF Co-generation Construction Site
- E. Information Memorandum: RWF Capital Improvement Program Semiannual Status Report

7. STATUS OF ITEMS PREVIOUSLY RECOMMENDED FOR APPROVAL BY TPAC

- A. Approval of Amended and Restated Design-Build Contract for the Final Design and Construction of the Headworks Project at the San José-Santa Clara Regional Wastewater Facility

Staff Recommendation:

1. Approve the Amended and Restated Design-Build Contract with CH2M HILL Engineers, Inc. for the final design, construction, commissioning and acceptance testing of the Headworks Project at the San José-Santa Clara Regional Wastewater Facility with a base Guaranteed Maximum Price in an amount not to exceed \$126,874,142.
2. Approve a ten percent construction contingency in the amount of \$12,688,000 for adjustments to the base Guaranteed Maximum Price in accordance with the Amended and Restated Design-Build Contract.

[SJ Headworks Amended and Restated DB Contract \(2-6-20\)](#)

[SJ Headworks Amended and Restated DB Contract Appendices \(2-6-20\)](#)

1. [Attachment 4A 60 pct Design Completion Documents Specifications Vol 1 of 5](#)
2. [Attachment 4A 60 pct Design Completion Documents Specifications Vol 2 of 5](#)
3. [Attachment 4A 60 pct Design Completion Documents Specifications Vol 3 of 5](#)
4. [Attachment 4A 60 pct Design Completion Documents Drawings Vol 4 of 5](#)
5. [Attachment 4A 60 pct Design Completion Documents Standard Details Vol 5 of 5](#)

This item was approved by the City Council on February 25, 2020.

- B. [Approval of a settlement agreement between City of San José and Brown and Caldwell related to the Digester and Thickener Facilities Upgrade Project.](#)

This item was approved by the City Council on February 25, 2020.

- C. [Second Amendment to the Consultant Agreement with Brown and Caldwell for Engineering Services for the Digester and Thickener Facilities Upgrade Project](#)

Staff Recommendation:

Approve the Second Amendment to the Consultant Agreement with Brown and Caldwell for engineering services for the Digester and Thickener Facilities Upgrade project at the San José-Santa Clara Regional Wastewater Facility, modifying the scope of services, extending the term of agreement from June 30, 2020 to December 31, 2021, and increasing the amount of compensation by \$2,530,734 for a total agreement amount not to exceed \$16,548,144, subject to the appropriation of funds.

This item was approved by the City Council on February 25, 2020.

- D. [Offer to Purchase Pond A-18](#)

Staff Recommendation:

Adopt a resolution authorizing the City Manager to negotiate an agreement with Valley Water for the sale of Pond A-18 and related easements to support the Shoreline Levee Project consistent with the criteria directed by the Treatment Plant Advisory Committee (TPAC) and Council in October of 2015 and 2017.

This item was approved by the City Council on April 14, 2020.

E. Declare Pond A-18 as Surplus Property

Staff Recommendation:

Adopt a resolution declaring the City's Pond A-18 property (Assessor's Parcel Numbers 015-32-042 and 015-32-043) as exempt surplus land under Cal. Gov. Code §54221 as the land is surplus to the needs of the City.

This item was approved by the City Council on April 14, 2020.

8. **REPORTS**

A. Open Purchase Orders Greater Than \$100,000 (including Service Orders)

The attached monthly Procurement and Contract Activity Reports summarizes the purchase and contracting between \$100,000 and \$1.3 Million for Goods and \$100,000 and \$320,000 for Services.

9. **MISCELLANEOUS**

A. The next TPAC Meeting is on **May 28, 2020, at 4:00 p.m.**, Virtual.

10. **OPEN FORUM**

11. **ADJOURNMENT**

NOTE: If you have any changes or questions, please contact April Kellett, Environmental Services (408) 975-2547.

To request an accommodation or alternative format for City-sponsored meetings, events or printed materials, please contact April Kellett (408) 975-2547 or (408) 294-9337 (TTY) as soon as possible, but at least three business days before the meeting/event.

Availability of Public Records. All public records relating to an open session item on this agenda, which are not exempt from disclosure pursuant to the California Public Records Act, that are distributed to a majority of the legislative body will be available for public inspection at San Jose City Hall, 200 East Santa Clara Street, 10th Floor, Environmental Services at the same time that the public records are distributed or made available to the legislative body.

**MINUTES OF THE
SAN JOSÉ/SANTA CLARA
TREATMENT PLANT ADVISORY COMMITTEE**

San José City Hall, T-1734
Thursday, February 13, 2020 at 4:10 p.m.

1. ROLL CALL

Minutes of the Treatment Plant Advisory Committee convened this date at 4:10p.m. Vice Chair Debi Davis called the meeting to order. Roll call was taken with the following members in attendance:

Committee Members: Debi Davis, Dev Davis, John Gatto, Lan Diep (4:11 p.m.), Carmen Montano, Dave Sykes, Kathy Watanabe

Absent: Sam Liccardo, Rowena Turner - Alternate, West Valley Sanitation District

2. APPROVAL OF MINUTES

A. December 12, 2019

On a motion made by Committee Member Gatto and a second by Committee Member Watanabe, TPAC recommended approval of the minutes.

Ayes – 6 (Debi Davis, Dev Davis, Gatto, Montano, Sykes, Watanabe)

Absent– 3 (Diep, Liccardo, Turner)

3. UNFINISHED BUSINESS/REQUEST FOR DEFERRALS

4. DIRECTOR'S REPORT

A. Director's Report (verbal)

Director Romanow shared a video report from 2/12/20 Water Board meeting where San José-Santa Clara Regional Wastewater Facility received their uncontested approval of the RWF's NPDES Permit. Board Chair, Jim McGrath complimented the City of San José for doing a really good job; Mr. McGrath commented that the consistently high-quality work done by the City resulted in vast improvements in quality of San Francisco Bay waters.

Director Romanow was available for questions regarding the November and December Monthly Reports.

Committee Member Gatto reported on an item from the recent CASA meeting he attended regarding land application as a disposal method [for biosolids]. He noted EPA's renewed interest in the presence of hazardous materials, including PFAS in biosolids from treatment plants, which could impact application of biosolids to agricultural lands.

5. **AGREEMENTS/ACTION ITEMS**

A. Approval of Amended and Restated Design-Build Contract for the Final Design and Construction of the Headworks Project at the San José-Santa Clara Regional Wastewater Facility

Staff Recommendation:

1. Approve the Amended and Restated Design-Build Contract with CH2M HILL Engineers, Inc. for the final design, construction, commissioning and acceptance testing of the Headworks Project at the San José-Santa Clara Regional Wastewater Facility with a base Guaranteed Maximum Price in an amount not to exceed \$126,874,142.
2. Approve a ten percent construction contingency in the amount of \$12,688,000 for adjustments to the base Guaranteed Maximum Price in accordance with the Amended and Restated Design-Build Contract.

[SJ Headworks Amended and Restated DB Contract \(2-6-20\)](#)

[SJ Headworks Amended and Restated DB Contract Appendices \(2-6-20\)](#)

[1. Attachment 4A_60 pct Design Completion](#)

[Documents_Specifications_Vol 1of5](#)

[2. Attachment 4A_60 pct Design Completion](#)

[Documents_Specifications_Vol 2of5](#)

[3. Attachment 4A_60 pct Design Completion](#)

[Documents_Specifications_Vol 3of5](#)

[4. Attachment 4A_60 pct Design Completion Documents_Drawings_Vol 4of5](#)

[5. Attachment 4A_60 pct Design Completion Documents_Standard Details_Vol 5of5](#)

Mariana Chavez-Vazquez, Deputy Director, presented on this Progressive Design Build project.

In response to questions from Committee Member Montano, Deputy Director Chavez-Vazquez clarified the benchmarking criteria used, the definition of Guaranteed Maximum Price (GMP) and GMP progression, the contingency amounts and percentages, and Performance Guarantees.

Committee Member Gatto asked for clarification about contingencies. Deputy Director Chavez-Vazquez clarified contractor-held contingencies versus owner-held contingencies. Committee Member Gatto also commented on project delivery costs that he considers overhead. Assistant Director Fukuda's offer to discuss definition of specific cost line items offline was accepted by Committee Member Gatto.

On a motion made by Committee Member Dev Davis and a second by Committee Member Diep, TPAC recommended approval of item 5. A.

Ayes – 7 (Debi Davis, Dev Davis, Diep, Gatto, Montano, Sykes, Watanabe)
Absent– 2 (Liccardo, Turner)

- B. Approval of a settlement agreement between City of San José and Brown and Caldwell related to the Digester and Thickener Facilities Upgrade Project.

Assistant Director Fukuda reminded the committee of the basis for this settlement agreement (i.e., digester project seismic uplift issue). He clarified categories that were negotiated as part of the settlement agreement. Committee Member Montano asked why we would continue to work with a contractor who made errors. He and Director Romanow reiterated the professionalism, honesty and general high performance of the consultant (e.g., Brown & Caldwell continued to work in good faith through the past several months without being paid).

On a motion made by Committee Member Gatto and a second by Committee Member Diep, TPAC recommended approval of item 5. B.

Ayes – 7 (Debi Davis, Dev Davis, Diep, Gatto, Montano, Sykes, Watanabe)
Absent– 2 (Liccardo, Turner)

- C. Second Amendment to the Consultant Agreement with Brown and Caldwell for Engineering Services for the Digester and Thickener Facilities Upgrade Project

Staff Recommendation:

Approve the Second Amendment to the Consultant Agreement with Brown and Caldwell for engineering services for the Digester and Thickener Facilities Upgrade project at the San José-Santa Clara Regional Wastewater Facility, modifying the scope of services, extending the term of agreement from June 30, 2020 to December 31, 2021, and increasing the amount of compensation by \$2,530,734 for a total agreement amount not to exceed \$16,548,144, subject to the appropriation of funds.

Deputy Director Mariana Chavez-Vazquez was available for questions.

On a motion made by Committee Member Diep and a second by Committee Member Dev Davis, TPAC recommended approval of item 5. C.

Ayes – 6 (Debi Davis, Dev Davis, Diep, Montano, Sykes, Watanabe)

Nays – 1 (Gatto)

Absent– 2 (Liccardo, Turner)

D. Offer to Purchase Pond A-18

Staff Recommendation:

Adopt a resolution authorizing the City Manager to negotiate and execute an agreement with Valley Water for the sale of Pond A-18 and related easements to support the Shoreline Levee Project consistent with the criteria directed by the Treatment Plant Advisory Committee (TPAC) and Council in October of 2015 and 2017.

Assistant Director of the Office of Economic Development and Director of Real Estate, Nanci Klein, presented on this item.

Committee Member [and San Jose City Manager] Dave Sykes, stated that he asked staff to bring this item to TPAC to assure San José's support and view of the importance of the Shoreline Project, to reaffirm its approach [that TPAC and Council approved in 2015 and 2017] to the property negotiations, and inform the committee of the present "gap" in the offer price and the City's evaluated value of the property. He also wanted to give Valley Water a chance to comment and answer any questions from TPAC members.

Committee Member Gatto asked whether the \$50M pump station was the RWF's cost. Assistant Director Fukuda responded affirmatively; adding that the project was always a project included in the RWF CIP but was needing to be accelerated due the Shoreline Project's timeline.

Vice Chair Debbie Davis stated that the City of Santa Clara City Manager wanted to introduce a letter from the City of Santa Clara City Manager, Deanna Santana, that was sent to City of San José City Manager Dave Sykes, reiterating that the City of Santa Clara [as co-owner] would need time to assess and obtain their Council approval prior to selling RWF property; also to state that Santa Clara supports the project.

Committee Member Gatto asked why Valley Water is interested in acquiring this property. Committee Member Sykes responded that Valley Water is charged with flood control and received Federal grant money for this project, and that the City of San José recognizes their purview and importance of the project.

Domingo Candelas, representative from Santa Clara Valley Water District, spoke urging the committee to support the transfer of ownership of Pond A-18 as expeditiously as possible to ensure that the Shoreline Levee Project remains on schedule. Mr. Candelas introduced his colleague Rachelle Blank, Subject Matter Expert on Shoreline Levee Project, saying she was available to answer questions.

Dean Stanford, citizen and park advocate, spoke against selling Pond A-18 until there are negotiations for maintaining the levee and keeping trail options open. Mr. Stanford provided handouts to Committee Members.

Rachelle Blank responded to questions from Committee Members regarding Shoreline Project plans for Pond A-18 related to ecosystem restoration, the recreational trail, and firmness of Valley Water's position on fair market value of Pond A-18. Ms. Blank described their appraisal process and perspective on fair market value. Assistant Director Klein and Committee Member [and San Jose City Manager] Sykes described City's appraisal process and differing perspective of fair market value and other related cost impacts.

Committee members discussed further and determined that Staff continue to negotiate with the goal of fair market value. Consequently, the Committee did not approve the Staff Recommendation as stated; rather, directed staff to come back in March with an update on the negotiations and proposed price, and provide additional information on the trail aspects of the Shoreline Project.

On a motion made by Committee Member Gatto and a second by Committee Member Watanabe, TPAC recommended approval of item 5. D as amended below:

Adopt a resolution authorizing the City Manager to negotiate and execute an agreement with Valley Water for the sale of Pond A-18 and related easements to support the Shoreline Levee Project consistent with the criteria directed by the Treatment Plant Advisory Committee (TPAC) and Council in October of 2015 and 2017. **Return to TPAC in March to report on negotiations and provide additional information regarding trail plans.**

Ayes – 7 (Debi Davis, Dev Davis, Diep, Gatto, Montano, Sykes, Watanabe)
Absent– 2 (Liccardo, Turner)

E. Declare Pond A-18 as Surplus Property

Staff Recommendation:

Adopt a resolution declaring the City's Pond A-18 property (Assessor's Parcel Numbers 015-32-042 and 015-32-043) as exempt surplus land under Cal. Gov. Code §54221 as the land is surplus to the needs of the City.

Yen Bui, Executive Analyst in Office of Economic Development, Real Estate presented.

Committee Members Watanabe and Montano separately requested and obtained confirmation that declaring Pond A-18 as surplus would not affect the fair market value of the property.

Committee Members Watanabe and Gatto asked whether denial of the previous item 5.D. precluded the approval of this item. Ms. Bui and City Attorney Pousho responded affirmatively. Dean Stanford, citizen and park advocate, spoke against declaring Pond A-18 as Surplus Property.

On a motion made by Committee Member Gatto and a second by Committee Member Sykes, TPAC recommended approval of item 5. E.

**Ayes – 7 (Debi Davis, Dev Davis, Diep, Gatto, Montano, Sykes, Watanabe)
Absent– 2 (Liccardo, Turner)**

6. **OTHER BUSINESS/CORRESPONDENCE**

A. Tributary Agencies Estimated Available Plant Capacity - 2019

7. **STATUS OF ITEMS PREVIOUSLY RECOMMENDED FOR APPROVAL BY TPAC**

A. Report on Bids and Award of Construction Contract for 7759 – Switchgear M4 Replacement and G3 & G3A Removal Project at the San José- Santa Clara Regional Wastewater Facility

Report on bids and award of construction contract for 7759 - Switchgear M4 Replacement and G3 & G3A Removal Project ("Project") to the lowest responsive bidder, Blocka Construction, Inc., in the amount of \$5,519,000, and approve a 15 percent construction contingency in the amount of \$827,850.

This item was approved by the City Council on December 17, 2019.

8. **REPORTS**

A. Open Purchase Orders Greater Than \$100,000 (including Service Orders)

The attached monthly Procurement and Contract Activity Report summarizes the purchase and contracting of goods with an estimated value between \$100,000 and \$1.17 million and of services between \$100,000 and \$290,000.

9. **MISCELLANEOUS**

A. The next monthly TPAC Meeting is on **March 12, 2020, at 4:00 p.m.**, City Hall, room 1734.

10. **OPEN FORUM**

11. **ADJOURNMENT**

A. The Treatment Plant Advisory Committee adjourned at 5:32 p.m.

Debi Davis, Vice Chair
TREATMENT PLANT ADVISORY COMMITTEE



San José-Santa Clara
Regional Wastewater Facility

Capital Improvement Program

Monthly Status Report: January 2020

March 5, 2020

This report summarizes the progress and accomplishments of the Capital Improvement Program (CIP) for the San José-Santa Clara Regional Wastewater Facility (RWF) for January 2020.

Report Contents

Project Delivery Models	2
Program Summary	3
Program Highlight	4
Program Performance Summary	6
Program Budget Performance Summary	7
Project Performance Summary	9
Project Significant Accomplishments	11
Explanation of Project Performance Issues	12
Regional Wastewater Facility Treatment – Current Treatment Process Flow Diagram	14
Regional Wastewater Facility Treatment – Proposed Treatment Process Flow Diagram	15
Active Construction Projects – Aerial Plan	16



Project Delivery Models

Design-Bid-Build Active Projects

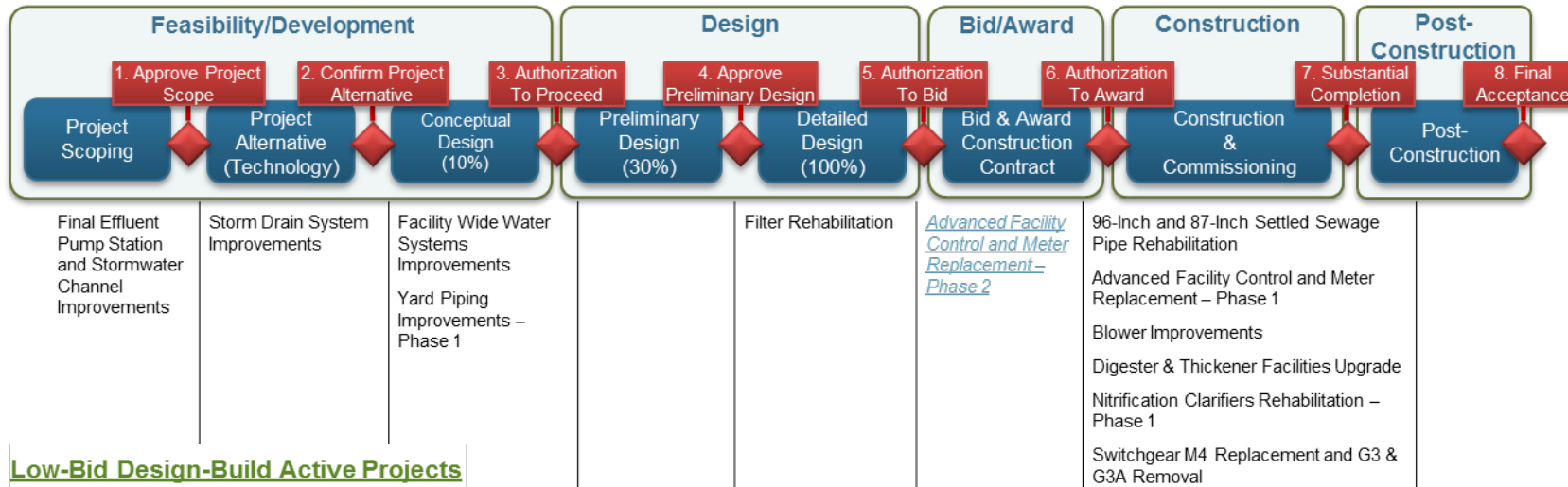

Low-Bid Design-Build Active Projects

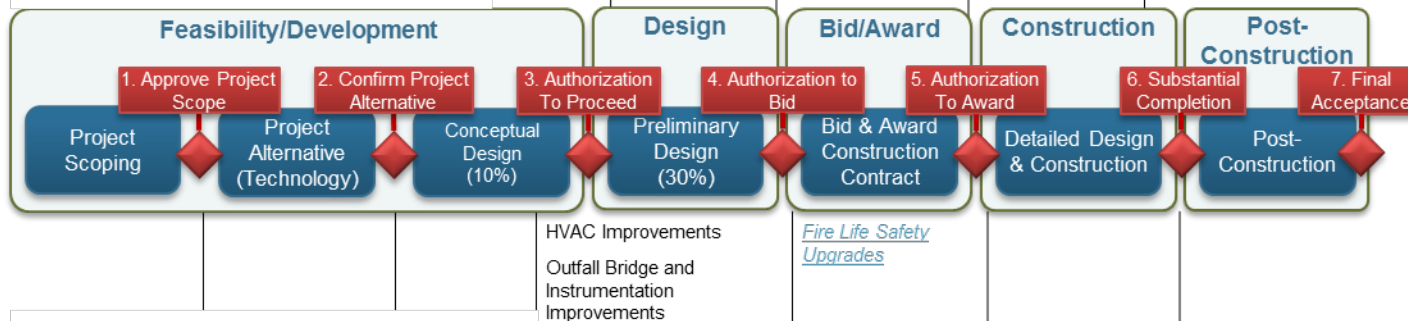

Progressive Design-Build Active Projects

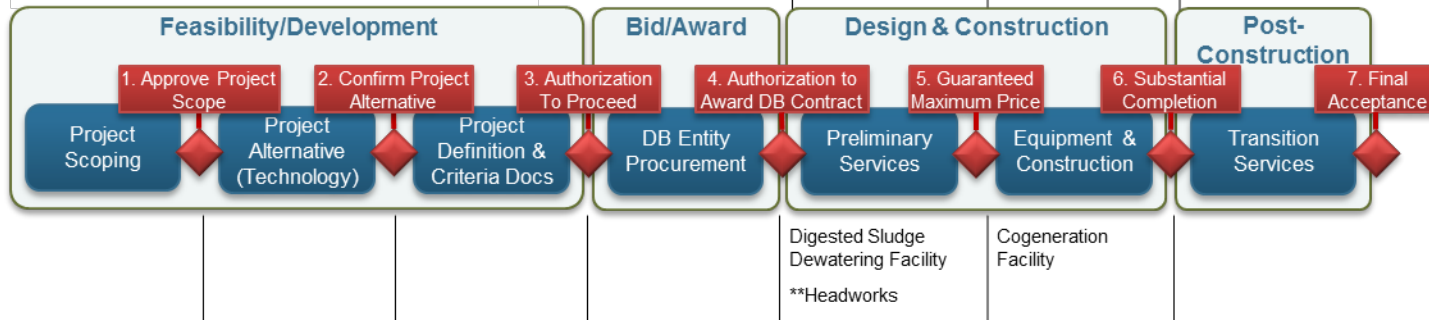

Key

- Phases
- Stages
- ◆ Stage Gates

*Projects shown underlined and in blue and italics have either been initiated or advanced this reporting period
 **Project will move to the next stage if City Council approves award of the construction contract.



Program Summary

January 2020

In January, two projects advanced through the Project Delivery Model (PDM). The Advanced Facility Control and Meter Replacement – Phase 2 and Fire Life Safety Upgrade projects were approved to proceed to the Bid and Award Construction Contract stage for design-bid-build and low-bid design-build delivery, respectively. The projects will be advertised in February and are anticipated to be awarded in June.

The Digester and Thickener Facilities Upgrade Project contractor connected the digested sludge export pump station to the overhead pipe rack and completed insulation of the hot water pipe. The contractor also installed a new 36-inch pressure flow pipe in the dissolved air flotation thickener (DAFT) gallery and removed the temporary re-route system, which had been operating for the past three months.



Figure 1: Cogeneration Facility Heat Exhaust Stacks Structural Steel

The Cogeneration Facility Project design-builder completed the cabinetry work in the Power and Air Operations Center, structural steel around the heat exhaust stacks (see Figure 1), and the Cogeneration Building and Power and Air Operations Center exterior concrete.

The Blower Improvements Project contractor completed demolition of air baghouses No.3 and 4 and replaced the Process Air Building blower No. 2 blowoff and discharge valves.

The Nitrification Clarifier Rehabilitation – Phase 1 Project team reviewed and provided comments on the contractor’s critical submittals, including baseline schedule, clarifier mechanism, motor control center enclosure, butterfly valves, and flow meters.

The design-builder for the Digested Sludge Dewatering Facility Project commenced a study to compare the performance of potential centrifuges that will inform the final centrifuge selection. Four manufacturers are participating, with the first manufacturer performing a series of project-specified tests with a trailer-mounted centrifuge. The design-builder also completed hazardous materials, soils, and geotechnical investigations at the proposed location of the future dewatering facility.

The CIP initiated the Energy Management Strategic Plan Update, which will revise the 2012 Energy Management Strategic Plan to reflect changes in the RWF’s energy sources and demands due to the completion of CIP projects and other external factors. The study will be performed in parallel with the Process Optimization Study, which was initiated in December 2019. The optimization study will identify and evaluate options for making unit treatment processes more efficient, while taking into account future regulatory changes and updated flow and load projections. Recommendations from both studies may impact the scope or timing of planned projects or identify future capital projects.

Look Ahead

The following key activities are forecast for February and March 2020:

- Staff will recommend to the Treatment Plant Advisory Committee and the San José City Council (Council):
 - Approval of the Definitive Contract Amendment (DCA) for the Headworks Project; and
 - Approval of a second amendment to the Brown and Caldwell (B&C) consultant agreement for the Digester & Thickener Facilities Upgrade Project to allow B&C to provide professional services through the end of construction
- The City will issue an NTP to the contractor for the Switchgear M4 Replacement and G3 & G3A Removal Project contractor.
- Five projects will seek to advance through the following stage gates:
 - Flood Protection – Stage Gate 1: Approve Project Scope
 - Storm Drain System Improvements – Stage Gate 2: Confirm Project Alternative
 - HVAC Improvements – Stage Gate 4: Authorization to Bid
 - Outfall Bridge and Instrumentation Improvements – Stage Gate 4: Authorization to Bid
 - Filter Rehabilitation – Stage Gate 5: Authorization to Bid
- Two studies will seek to advance through Stage Gate 1: Approve Project Scope:
 - Process Optimization
 - Energy Management Strategic Plan Update

Program Highlight

96-Inch and 87-Inch Settled Sewage Pipe Rehabilitation Project

Seventy percent of the RWF's more than 300,000 linear feet (LF) of piping is at least 25 years old. A June 2015 study identified 16 pipe segments, totaling 21,000 LF, as high priority. In 2017, the Digester and Thickener Facilities Upgrade Project discovered severe crown corrosion during a planned connection to one of these high-priority pipes, a 78-inch settled sewage (SES) pipe. While the 78-inch pipe was under repair, the CIP directed Black and Veatch (B&V) to conduct a condition assessment of the adjacent circular 96-inch pipe and elliptical 87 by 136-inch pipe (see Figure 2). The inspection confirmed severe crown corrosion in both of those pipes (see Figures 3 and 4).

The 96-inch SES pipeline connects to the 78-inch SES pipeline at the "Wye" Structure and enters the 87 by 136-inch SES pipeline to convey primary effluent from the east primary clarifiers to the SES pump station. From there the effluent is distributed to the secondary treatment process for further treatment. The two pipelines are critical to RWF operations, as they carry more than 100 million gallons per day of wastewater during dry weather. Due to the criticality of the pipes, the City decided to expedite their rehabilitation using the conventional design-bid-build approach.

In September 2018, B&V analyzed estimated costs, constructability, hydraulic impact, and service life of various rehabilitation methods for the two pipe segments. The cured-in-place pipe rehabilitation method was selected for the 96-Inch SES pipe and concrete crown repair with an epoxy coating rehabilitation method for the 87 by 136-inch pipe. In February 2019, B&V completed the detailed design.

In April 2019, the City completed a contractor pre-qualification process and, in July, advertised the construction contract to the three pre-qualified contractors. The City received two bids and awarded the construction contract to the low bidder, Michels Pipeline Corporation, in November.

The City will issue the construction Notice to Proceed and the project team will begin reviewing contractor submittals in February 2020. Construction work is expected to begin in April, with Substantial Completion expected in October. To facilitate the construction, O&M staff will be re-using a re-route system to convey the primary effluent from the east primary clarifiers to the SES Pump Station. This re-route system was originally procured and installed as part of the replacement work for the 78-inch SES pipeline (see Figure 5). The total project budget is \$8.7 million.

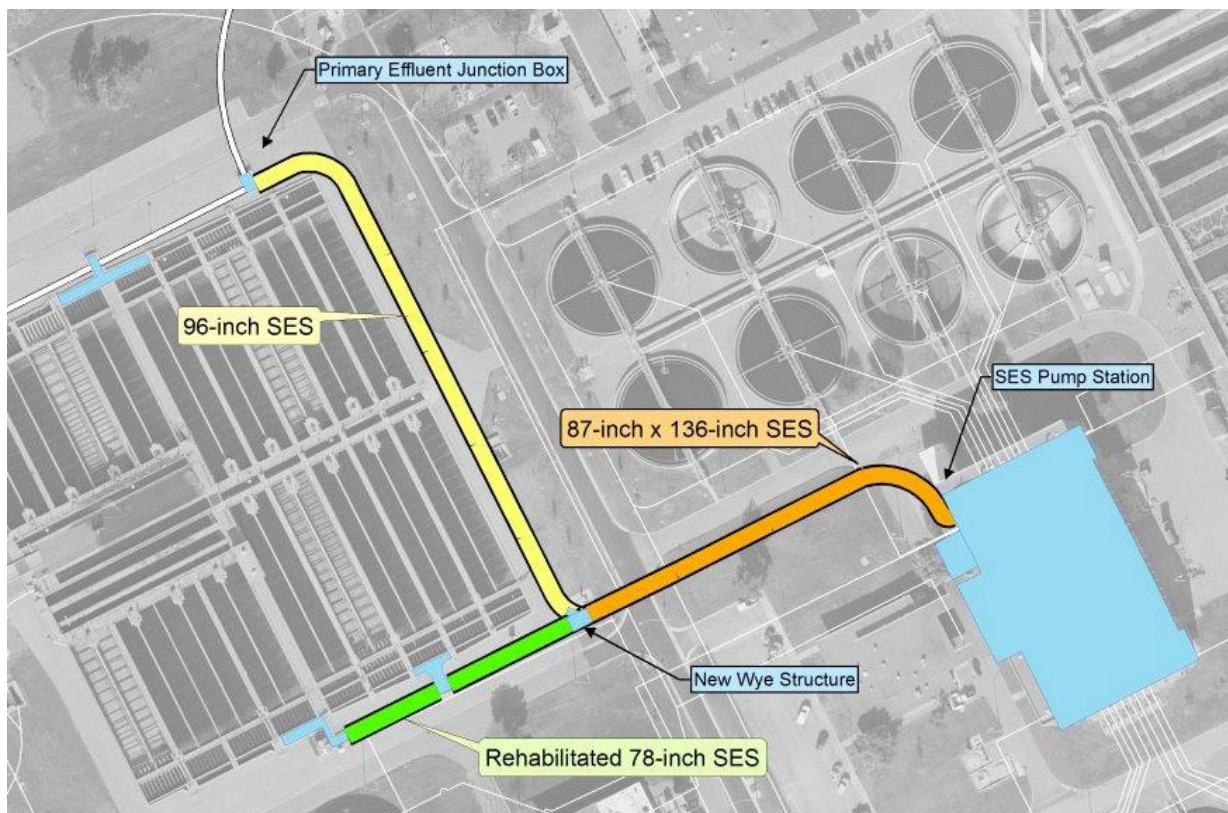

Figure 2: Site Map



Figure 3: Rebar degradation of 96-inch SES pipeline



Figure 4: Crown corrosion of 87 by 136-inch SES pipeline



Figure 5: 78-Inch SES Reroute System Outlined in Orange

Program Performance Summary

Eight key performance indicators (KPIs) have been established to measure overall CIP success. Each KPI represents a metric that will be monitored on a regular basis. Through the life of the CIP, KPIs that best reflect the current program will be selected and measured. KPIs are reset each fiscal year.

Program Key Performance Indicators – Fiscal Year 2019-2020

KPI	Target	Fiscal Year to Date			Fiscal Year End		
		Actual	Status	Trend	Forecast	Status	Trend
Stage Gates	90%	92% 12/13			95% 19/20		
Measurement: Percentage of initiated projects and studies that successfully pass each stage gate on their first attempt. Target: Green: >= 90%; Amber: 75% to 90%; Red: < 75%							
Schedule¹	90%	N/A 0/0	N/A	N/A	N/A 0/0	N/A	N/A
Measurement: Percentage of CIP projects delivered within 2 months of approved baseline Beneficial Use Milestone. ² Target: Green: >= 90%; Amber: 75% to 90%; Red: < 75%							
Budget³	90%	N/A 0/0	N/A	N/A	N/A 0/0	N/A	N/A
Measurement: Percentage of CIP projects that are accepted by the City within the approved baseline budget. ² Target: Green: >= 90%; Amber: 75% to 90%; Red: < 75%							
Expenditure⁴	\$370M	\$217M			\$411M		
Measurement: CIP FY19-20 committed costs. Target: Committed costs meets or exceeds 70% of planned budget. 70% of \$528M = \$370M. Therefore Fiscal Year End Green: >=\$370M; Red: < \$370M							
Procurement⁵	80%	67% 4/6			100% 6/6		
Measurement: Number of consultant and contractor procurements advertised compared to planned for the fiscal year. Target: Green: >= 80%; Amber: 70% to 80%; Red: < 70%							
Safety	0	0			0		
Measurement: Number of OSHA reportable incidents associated with CIP delivery for the fiscal year. Criteria: Green: zero incidents; Amber: 1 to 2; Red: > 2							
Environmental	0	1			0		
Measurement: Number of permit violations caused by CIP delivery for the fiscal year. Target: Green: zero incidents; Amber: 1 to 2; Red: > 2							
Vacancy Rate⁶	10%	14% 12/86 ⁷			9% 8/86		
Measurement: Ratio of the number of vacant approved positions to approved positions. Target: Green: <= 10%; Amber: 10% to 20%; Red: > 20%							

Notes

- The CIP does not anticipate any projects reaching Beneficial Use this fiscal year.
- The baseline Beneficial Use date and the baseline budget for each project are established at construction contract award and execution.
- The CIP does not anticipate accepting any projects this fiscal year.
- The Expenditure fiscal year to date status is shown yellow due to the Headworks DCA, which was anticipated to be encumbered in January 2020, but will now be encumbered in March 2020.
- The City advertised the Fire Life Safety Upgrades Project low-bid design-build contract and the Advanced Facility Control and Meter Replacement – Phase 2 Project construction contract. The Filter Rehabilitation Project originally planned to be advertised this month is now expected to be advertised in March. Additionally, advertisements of the HVAC Improvements and Yard Piping and Road Improvements projects have been removed from the KPI due to resequencing of construction priorities and change in delivery strategy, respectively.
- The vacancy rate KPI measures CIP-approved positions, including ESD, Public Works, and program management consultant full-time staff.
- The vacancy count decreased by four.



Program Budget Performance Summary

This section summarizes the cumulative monthly budget performance for fiscal year (FY)19-20 based on the Adopted 2020-2024 CIP.

Adopted 2020-2024 CIP Expenditure and Encumbrances

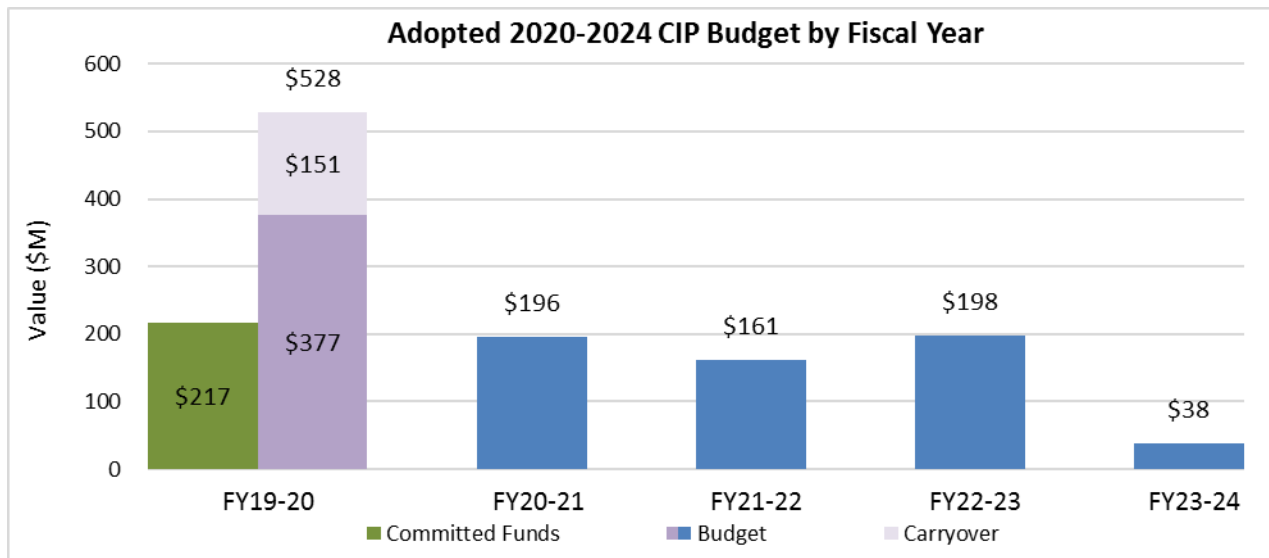

Notes:

Committed Funds: Total of expenditures and encumbrances.

Expenditure: Actual cost expended, either by check to a vendor or through the City's financial system, for expenses such as payroll or for non-personal expenses that do not require a contract.

Encumbrance: Financial commitments such as purchase orders or contracts that are committed to a vendor, consultant, or contractor. An encumbrance reserves the funding within the appropriation and project.

The FY19-20 budget is \$401.5 million, which consists of \$339.6 million in new funds, \$61.9 million in rebudgets. For purposes of this monthly report, the adopted FY19-20 budget is adjusted from \$401.5 million to \$377.2 million due to the exclusion of certain appropriations that are not measured as part of the expenditure KPI. Excluded appropriations include City Hall Debt Service Fund; Clean Water Financing Authority Debt Service Payment Fund; Debt Service Repayment for Plant Capital Improvement Projects (San José only debt service); Equipment Replacement Reserve; Ending Fund Balance; Public Art; City Facilities Emergency Power, and Urgent and Unscheduled Treatment Plant Rehabilitation. Similar adjustments have been made to the budgets for FY20-21 through FY23-24.

Carryover: Encumbrance balances at the end of the previous fiscal year are automatically carried forward to the current fiscal year as carryover funding to pay invoices for approved construction contracts and consultant agreements. FY19-20 carryover is \$151.0 million.

Budget of \$377.2 million and carryover of \$151.0 million totals \$528.2 million for FY19-20.



Fiscal Year 2019-2020 Program Budget Performance

The FY19-20 CIP budget is comprised of approximately \$377.2 million in new and rebudgeted funds, plus encumbered carryover of \$151.0 million, for a total of \$528.2 million. This excludes City Hall Debt Service Fund; Clean Water Financing Authority Debt Service Payment Fund; Debt Service Repayment for Plant Capital Improvement Projects (San José only debt service); Equipment Replacement Reserve; Ending Fund Balance; Public Art; City Facilities Emergency Power; and Urgent and Unscheduled Treatment Plant Rehabilitation items. Overall, the forecast fiscal year-end committed funds exceed the fiscal year-end target by \$40 million.

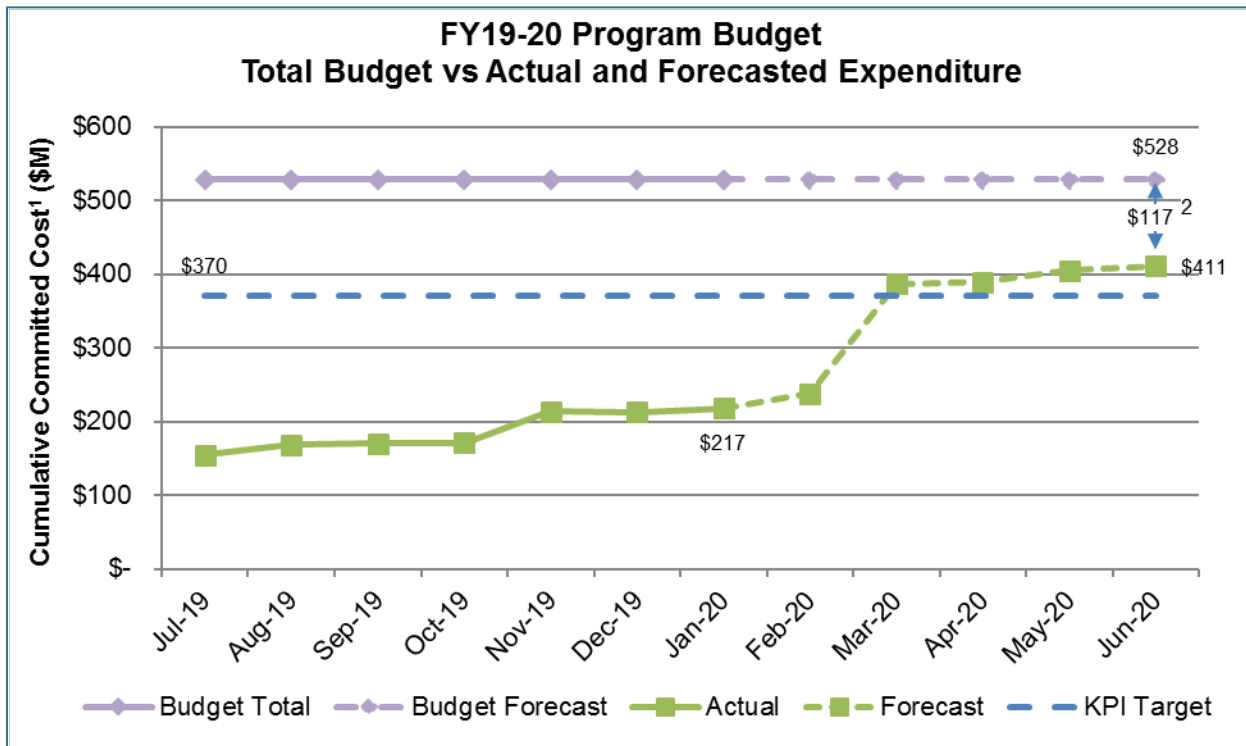

Notes:















1. Committed costs are expenditures and encumbrance balances, including carryover (encumbrance balances from the previous fiscal year).
2. The variance between budget and commitments can be primarily attributed to the following factors:
 - a. Three construction contracts are now anticipated to not be awarded in FY19-20, based on updated schedules:
 - i. Filter Rehabilitation Project
 - ii. HVAC Improvements
 - iii. Outfall Bridge and Instrumentation Improvements Project
 - b. Several consultant service orders are not anticipated to be awarded in FY19-20:
 - i. Aeration Tank Rehabilitation Project conceptual through final design
 - ii. Facility Wide Water Systems Improvements Project preliminary engineering and value engineering
 - iii. Flood Protection Project alternatives analysis and conceptual design
 - c. The Yard Piping and Road Improvements Project design and first phase of construction will no longer occur this fiscal year.
 - d. The Nitrification Clarifiers Rehabilitation – Phase 1 Project construction bids came in under budget.
 - e. Several other minor encumbrances for consultant services are either lower than budgeted or are anticipated to be awarded in FY20-21.
 - f. Several authorized positions remain vacant, resulting in lower personal services expenses than budgeted.



Project Performance Summary

There are currently seven projects in the construction and post-construction phases and an additional 11 projects in feasibility/development, design, bid and award, or design and construction phases (see PDM, page 2). Projects in the construction phase have established cost and schedule baselines and are monitored using the City's Capital Project Management System (CPMS). Green/red icons are included in the table below to indicate whether these projects are on budget and schedule.

Project Performance – Baselined Projects

Project Name	Phase	Estimated Beneficial Use Date ¹	Cost Performance ²	Schedule Performance ²
1. Cogeneration Facility	Design & Construction	Sep 2020		
2. Digester and Thickener Facilities Upgrade	Construction	Nov 2020		
3. 96-Inch and 87-Inch Settled Sewage Pipe Rehabilitation	Construction	Jan 2021		
4. Advanced Facility Control & Meter Replacement - Phase 1	Construction	June 2021		
5. Switchgear M4 Replacement and G3 & G3A Removal	Construction	June 2022 ³		
6. Blower Improvements	Construction	Sep 2022		
7. Nitrification Clarifiers Rehabilitation – Phase 1	Construction	Jan 2023		

Key:

Cost:	 On Budget	 >1% Over Budget	Schedule:	 On Schedule	 >2 months delay
--------------	---	---	------------------	---	---

Notes

- Beneficial Use is defined as work that is sufficiently complete, in accordance with contract documents, that it can be used or occupied by the City. Beneficial Use dates are reviewed as part of project schedule reviews.
- An explanation of cost and schedule variances on specific projects identified in this table is provided on page 12.
- The project construction Beneficial Use date will be baselined once the City issues the construction contract NTP letter.



Project Performance – Pre-Baselined Projects

Project Name	Phase	Estimated Beneficial Use Date ¹
1. Headworks	Design and Construction	Jun 2023
2. Digested Sludge Dewatering Facility	Design and Construction	Nov 2023
3. Fire Life Safety Upgrades	Bid/Award	Jul 2022
4. Advanced Facility Control & Meter Replacement - Phase 2	Bid/Award	Jan 2023
5. Outfall Bridge and Instrumentation Improvements	Design	Dec 2021
6. Filter Rehabilitation	Design	Jul 2023
7. HVAC Improvements	Design	Feb 2025
8. Yard Piping Improvements – Phase 1	Feasibility/Development	Oct 2021
9. Storm Drain System Improvements	Feasibility/Development	Sep 2023
10. Facility Wide Water Systems Improvements	Feasibility/Development	Jan 2025
11. Final Effluent Pump Station and Stormwater Channel Improvements	Feasibility/Development	May 2026

Notes

1. Beneficial Use is defined as work that is sufficiently complete, in accordance with contract documents, that it can be used or occupied by the City. Beneficial Use dates are reviewed as part of project schedule reviews.



Project Significant Accomplishments

Biosolids Package

Digested Sludge Dewatering Facility Project

- The first of four centrifuge manufacturers began demonstrating centrifuge performance with RWF digested sludge. The remaining manufacturers will complete their demonstrations over the next few months. The project team will select the centrifuge for the dewatering facility from the results of these demonstrations.
- Walsh completed the hazardous materials investigation and the soils and geotechnical investigations. Analyses and reports are expected by March 2020.

Digester and Thickener Facilities Upgrade Project

- Contractor Walsh installed the elevated pipe rack hot water pipe insulation from the compressor building to the new cogeneration facility connection point and connected the digested sludge export pump station to the pipe rack.
- At the new sludge screening building, Walsh finished installing driveway aprons and east stair landing concrete, primary sludge piping, the monorail crane in the grit extraction room, and the exterior architectural finish.
- Walsh removed the temporary 36-inch pressure flow pipe re-route system after completing installation and operation of the new 36-inch pressure flow pipe.

Facilities Package

96-Inch and 87-Inch Settled Sewage Pipe Rehabilitation Project

- The City held a pre-construction meeting. Next month, the City will issue the NTP to contractor Michels Pipeline Construction.

Fire Life Safety Upgrades Project

- The City advertised the project construction contract and conducted a non-mandatory, pre-bid walk. Bids are due February 20 with award of the contract expected in June 2020.

Storm Drain System Improvements Project

- Design consultant AECOM held a workshop to discuss findings, alternatives, and recommendations from the recently completed flood risk analysis. Next month, the project will seek approval to move into conceptual design.

Liquids Package

Advanced Facility Control and Meter Replacement – Phase 1 Project

- Contractor Overaa finished installing the flow transmitters in the secondary tunnel. The functional test of the new equipment in secondary tanks B1 to B4 and secondary clarifiers is expected to begin in March 2020.

Advanced Facility Control and Meter Replacement – Phase 2 Project

- The City advertised the project construction contract and conducted a non-mandatory, pre-bid meeting in January. Bids are due February 20 with award of the contract expected in June 2020.

Blowers Improvements Project

- Contractor Monterey Mechanical replaced the Process Air Building blower No 2 blowoff and discharge valves and installed the discharge check valve.
- Monterey Mechanical also completed the Tertiary Blower Building air baghouses No 3 and No 4 demolition.

Filter Rehabilitation Project

- Staff began review of the 100 percent design and cost estimate submittals. The project team anticipates advancing through the Authorization to Bid stage gate next month.

Nitrification Clarifier Rehabilitation - Phase 1 Project

- The project team reviewed and provided comments on the contractor's critical submittals, including the baseline schedule, clarifier mechanism, motor control center enclosure, butterfly valves, and flow meters.

Power and Energy Package

Cogeneration Facility Project

- Design-builder CH2M completed the cabinetry work in the Power and Air Operations Center; structural steel around the heat exhaust stacks connected to the Cogeneration Building; and exterior concrete for curb and gutters around the site.



Explanation of Project Performance Issues

Digester and Thickener Facilities Upgrade Project

This project encountered numerous unforeseen conditions at the beginning of construction in 2016, including corroded underground pipe and other obstructions for new building foundations. A temporary reroute system was installed to enable the replacement of a 78-inch settled sewage pipeline and junction structure during the 2018 dry season.

In 2017, design modifications were required to address seismic risks, control system changes, additional underground obstructions, pipe anchorage, and new fire department requirements. Discovery of hazardous materials required submittal of an extensive cleanup proposal to the federal Environmental Protection Agency (EPA) for approval. Once mitigation was completed in 2019, the City submitted another report to the EPA that detailed how it met each EPA cleanup permit requirement.

To pay for the additional work to address unforeseen conditions, Council approved a construction contingency increase of \$15 million in November 2017 and another contingency increase of \$25 million in June 2018.

Delays for these conditions have amounted to 273 working days. The original construction completion and Beneficial Use date of September 2019 has been delayed and rescheduled to November 2020. To minimize further delays, the City and contractor have worked together to sequence several tasks so that they could be completed more quickly and efficiently.



Page Left Intentionally Blank



Regional Wastewater Facility Treatment – Current Treatment Process Flow Diagram

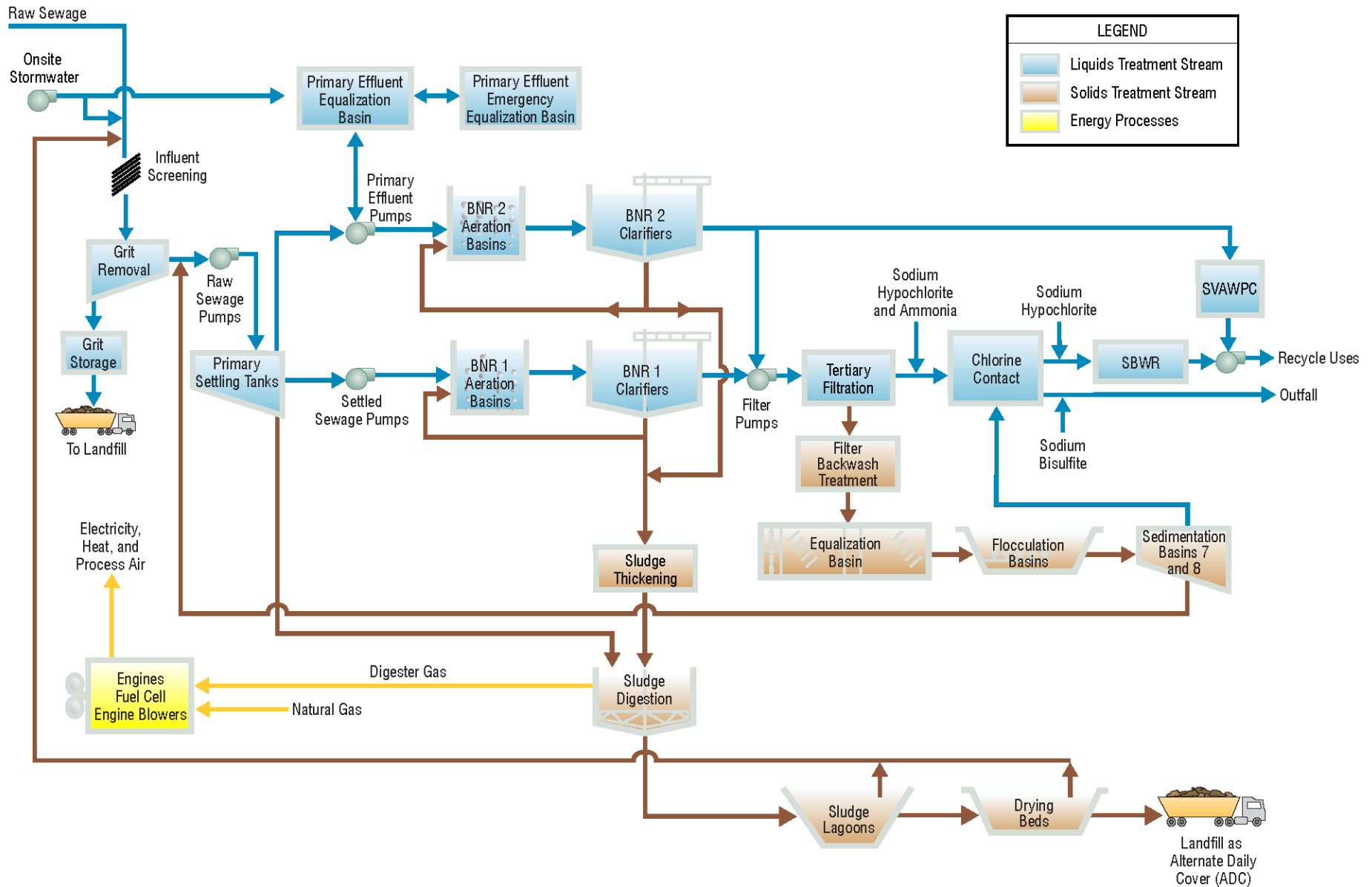

Figure 6 – Current Treatment Process Flow Diagram



Regional Wastewater Facility Treatment – Proposed Treatment Process Flow Diagram

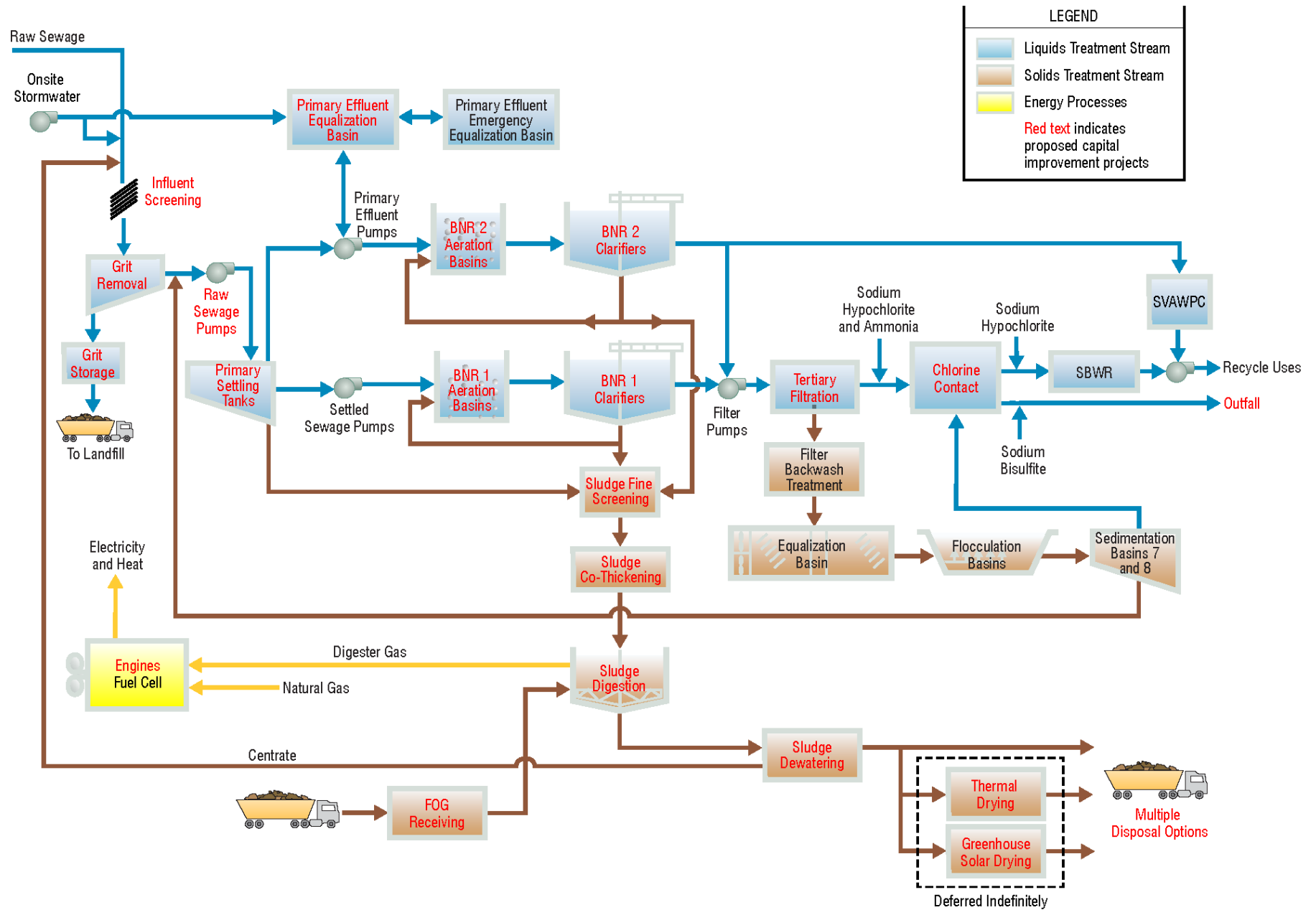

Figure 7 – Proposed Treatment Process Flow Diagram



Active Construction Projects – Aerial Plan

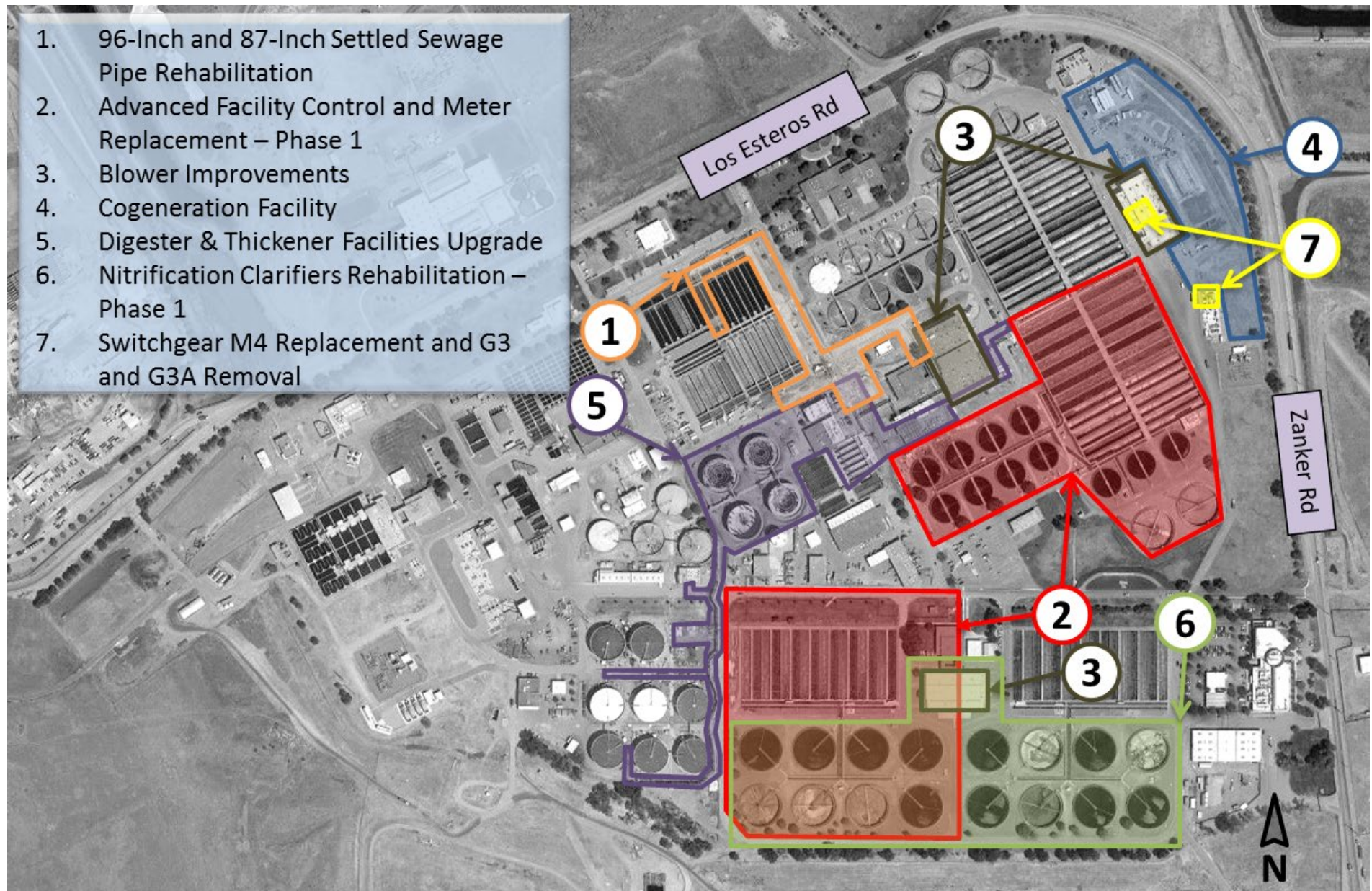

Figure 8: Active Construction Projects



San José-Santa Clara
Regional Wastewater Facility

Capital Improvement Program

Monthly Status Report: February 2020

April 2, 2020

This report summarizes the progress and accomplishments of the Capital Improvement Program (CIP) for the San José-Santa Clara Regional Wastewater Facility (RWF) for February 2020.

Report Contents

Project Delivery Models	2
Program Summary	3
Program Highlight – Construction Activity.....	4
Program Performance Summary	7
Program Budget Performance Summary	8
Project Performance Summary	10
Project Significant Accomplishments	12
Explanation of Project Performance Issues	13
Regional Wastewater Facility Treatment – Current Treatment Process Flow Diagram	14
Regional Wastewater Facility Treatment – Proposed Treatment Process Flow Diagram.....	15
Active Construction Projects – Aerial Plan.....	16



Project Delivery Models

Design-Bid-Build Active Projects

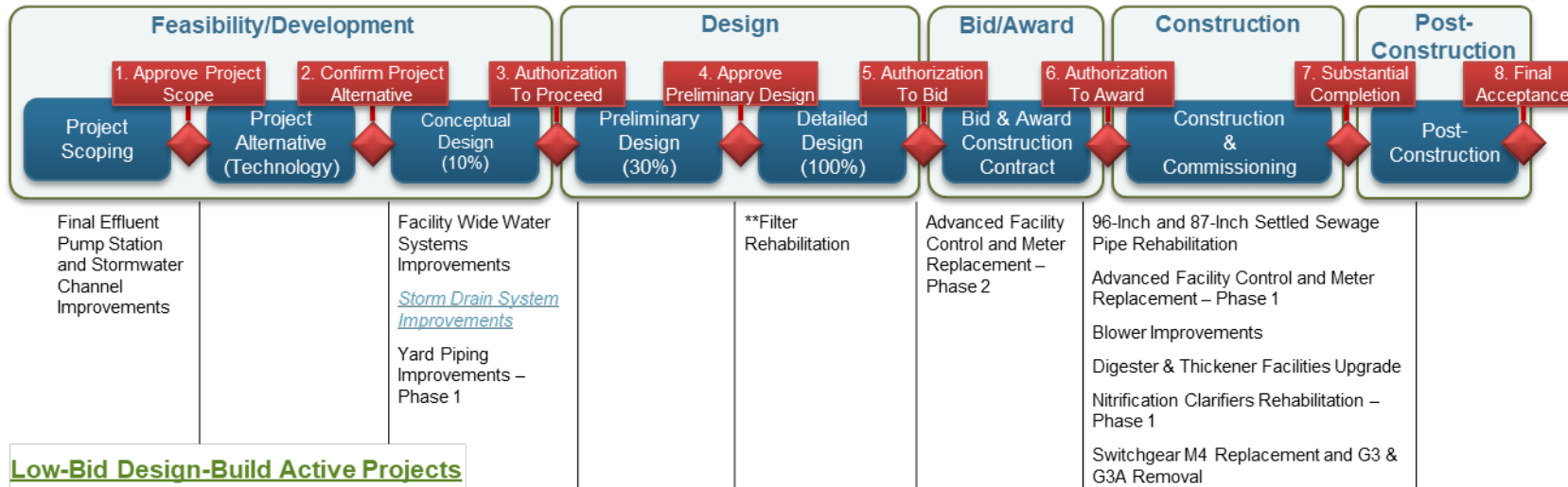

Low-Bid Design-Build Active Projects

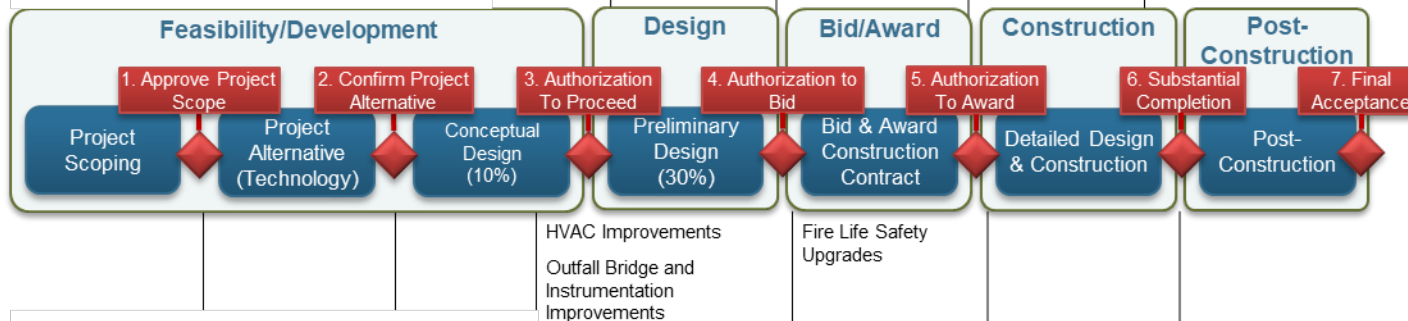

Progressive Design-Build Active Projects

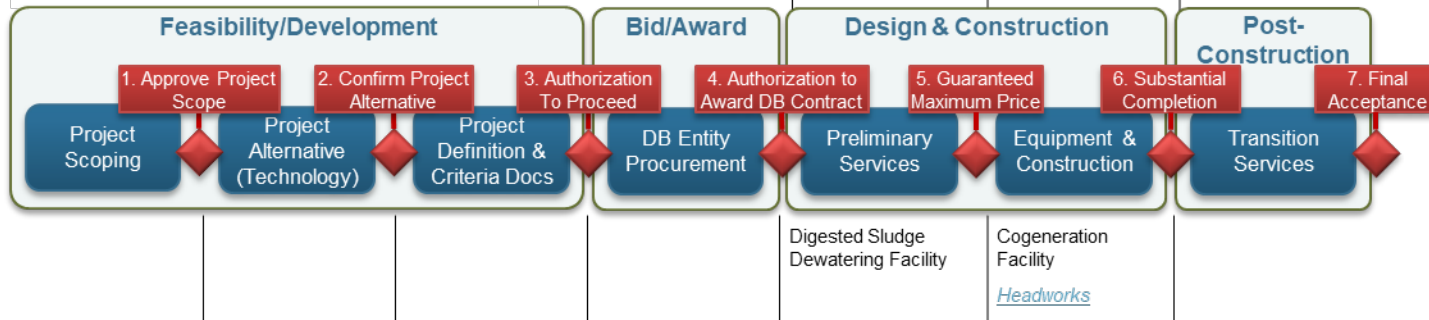

Key

- Phases
- Stages
- ◆ Stage Gates

*Projects shown underlined and in blue and italics have either been initiated or advanced this reporting period
 **Project will move to the next stage once the Plans and Specification Authorization to Advertise Memorandum is signed by the Director of Public Works.



Program Summary

February 2020

In February, the Treatment Plant Advisory Committee (TPAC) and the San José City Council (Council) approved the amended and restated design-build contract with CH2M HILL Engineers, Inc. (CH2M) for final design and construction of the Headworks Project. The award was a major project and CIP milestone. For the project, it was the culmination of several months of negotiations with the design-builder. For the CIP, it was the award of the program's largest construction contract. CH2M will now continue design and prepare for major construction to begin this summer.

Two projects advanced through the Project Delivery Model (PDM). The Filter Rehabilitation Project was approved to proceed to the Bid and Award Construction Contract stage. The Storm Drain Systems Improvement Project was approved to proceed with conceptual design after conducting additional flood risk analysis and sensitivity analysis of critical infrastructure, refining the design criteria, and conducting a more robust assessment of the alternative strategies for meeting the design criteria.



Figure 1: Aerial view of the Digester 5 (left) and Digester 6 (right) gas withdrawal system

The Digester and Thickener Facilities Upgrade Project contractor continued remaining work on Digesters 5 through 8, installing sludge flow equipment concrete pads, electrical conduits, roof gas piping, gas domes, and stairways. At the new Sludge Screening Building, the contractor completed HVAC ductwork on the roof and screening bin room. The contractor also installed the hot water supply, return piping, and digester gas piping on the elevated pipe rack along C Street.

The Cogeneration Facility Project design-builder installed and tested the backup battery system; cleaned and tested the medium voltage (4160 V) switchgear; and finished the site paving.

The Blower Improvements Project contractor demolished the last of the five Tertiary Blower Building air baghouses.

The Advanced Facility Control and Meter Replacement – Phase 1 Project contractor replaced and installed three new total suspended solids (TSS) meters and verified performance.

The Nitrification Clarifier Rehabilitation – Phase 1 Project team reviewed and returned the contractor's submittals, including slide gate and telescoping valves, butterfly valves, stainless steel pipe, flow meters, electrical components, temporary facilities, and controls.

The City issued the Notice to Proceed (NTP) for the 96-Inch and 87-Inch Settled Sewage Pipe Rehabilitation Project.

The City received two construction bids for the Advanced Facility Control and Meter Replacement – Phase 2 Project; both bids below the engineer's estimate. The CIP will recommend that Council award the construction contract in June 2020.

The design-builder for the Digested Sludge Dewatering Facility Project continued a study to compare centrifuge performance for final centrifuge selection. Two manufacturers completed performance testing for the study. CIP and operations and maintenance (O&M) representatives visited East Bay Municipal Utility District and the Union Sanitary District centrifuge facilities to learn more about the conveyor systems used at these facilities.

Look Ahead

The following key activities are forecast for March and April 2020:

- The City will issue an NTP to the contractor for the Switchgear M4 Replacement and G3 & G3A Removal Project.
- Two projects will seek to advance through the following stage gates:
 - Flood Protection Project – Stage Gate 1: Approve Project Scope
 - Yard Piping Improvements – Phase 1 Project – Stage Gate 3: Authorization to Proceed
- Two studies will seek to advance through the following stage gates:
 - Process Optimization Study – Stage Gate 1: Approve Project Scope
 - Energy Management Strategic Plan Update Study - Stage Gate 1: Approve Project Scope



Program Highlight – Construction Activity

The following photographs show the progress made on several major RWF construction projects over the past six months.

Blower Improvements Project



Figure 2: Reoriented and refurbished mechanical system, including a new motor and various utilities connections, for one of the blowers in the Power and Air Building.

Figure 3: The contractor prepares the existing electrical conduit system maintenance access point for additional conduit connections. The existing rebar locations are marked on the outside of the concrete junction structure to guide new conduit positioning.



Advanced Facility Control and Meter Replacement – Phase 1 Project



Figure 4: The contractor performs electrical instrumentation adjustments and verifies readings with an existing distributed control system (DCS) node.

Figure 5: The contractor verifies a new DCS node located in one of the many tunnels during functional testing.



Cogeneration Facility Project



Figure 6: New gas treatment system which cleans impurities from the digester gas prior to being used by the internal combustion engines to produce electricity and heat.

Figure 7: The electricity generated by the new engines will use this medium voltage (4160 Volt) switchgear to distribute power to equipment throughout the RWF. The workers shown are testing the wiring and protective relay settings prior to putting the switchgear into service.



Figure 8: The new engine generators' high exhaust heat is used to produce hot water, which is then used to provide heat to the digesters and other facilities. The exhaust gas is cleaned through a treatment system before being discharged through the exhaust stacks.

Digester and Thickener Facilities Upgrade Project



Figure 9: The upgraded foam suppression and withdrawal pumps and visible piping for thermophilic Digesters 5 and 7.

Figure 10: The automated polymer blending system will feed polymer to the blended sludge prior to entering the dissolved air flotation thickener tanks.



Figure 11: The Digester 5 gas withdrawal system is comprised of injection piping shown nearest, and pressure relief valves and digester gas separators in the distance. The digester gas will be used by the new Cogeneration Facility engines to generate electricity and heat for the RWF.

Figure 12: The new electricity load center at 5th and Center Streets will reduce the grid voltage to power the digester equipment.



Program Performance Summary

Eight key performance indicators (KPIs) have been established to measure overall CIP success. Each KPI represents a metric that will be monitored on a regular basis. Through the life of the CIP, KPIs that best reflect the current program will be selected and measured. KPIs are reset each fiscal year.

Program Key Performance Indicators – Fiscal Year 2019-2020

KPI	Target	Fiscal Year to Date			Fiscal Year End		
		Actual	Status	Trend	Forecast	Status	Trend
Stage Gates	90%	93% 14/15 ¹			95% 19/20		
Measurement: Percentage of initiated projects and studies that successfully pass each stage gate on their first attempt. Target: Green: >= 90%; Amber: 75% to 90%; Red: < 75%							
Schedule²	90%	N/A 0/0	N/A	N/A	N/A 0/0	N/A	N/A
Measurement: Percentage of CIP projects delivered within 2 months of approved baseline Beneficial Use Milestone. ³ Target: Green: >= 90%; Amber: 75% to 90%; Red: < 75%							
Budget⁴	90%	N/A 0/0	N/A	N/A	N/A 0/0	N/A	N/A
Measurement: Percentage of CIP projects that are accepted by the City within the approved baseline budget. ³ Target: Green: >= 90%; Amber: 75% to 90%; Red: < 75%							
Expenditure	\$370M	\$226M			\$408M ⁵		
Measurement: CIP FY19-20 committed costs. Target: Committed costs meets or exceeds 70% of planned budget. 70% of \$528M = \$370M. Therefore Fiscal Year End Green: >=\$370M; Red: < \$370M							
Procurement	80%	67% 4/6			100% 6/6		
Measurement: Number of consultant and contractor procurements advertised compared to planned for the fiscal year. Target: Green: >= 80%; Amber: 70% to 80%; Red: < 70%							
Safety	0	0			0		
Measurement: Number of OSHA reportable incidents associated with CIP delivery for the fiscal year. Criteria: Green: zero incidents; Amber: 1 to 2; Red: > 2							
Environmental⁶	0	1			0		
Measurement: Number of permit violations caused by CIP delivery for the fiscal year. Target: Green: zero incidents; Amber: 1 to 2; Red: > 2							
Vacancy Rate⁷	10%	14% 12/86			9% 8/86		
Measurement: +B3:125 Ratio of the number of vacant approved positions to approved positions. Target: Green: <= 10%; Amber: 10% to 20%; Red: > 20%							

Notes

1. The Filter Rehabilitation and Storm Drain System Improvements projects passed Stage Gate 5: Authorization to Bid and Stage Gate 2: Confirm Project Alternative, respectively.
2. The CIP does not anticipate any projects reaching Beneficial Use this fiscal year.
3. The baseline Beneficial Use date and the baseline budget for each project are established at construction contract award and execution.
4. The CIP does not anticipate accepting any projects this fiscal year.
5. The program fiscal-year-end value decreased as encumbrance timing on several projects shifted.
6. The City has appealed the environmental violation and is awaiting a response from the issuing agency.
7. The vacancy rate KPI measures CIP-approved positions, including ESD, Public Works, and program management consultant full-time staff.



Program Budget Performance Summary

This section summarizes the cumulative monthly budget performance for fiscal year (FY)19-20 based on the Adopted 2020-2024 CIP.

Adopted 2020-2024 CIP Expenditure and Encumbrances

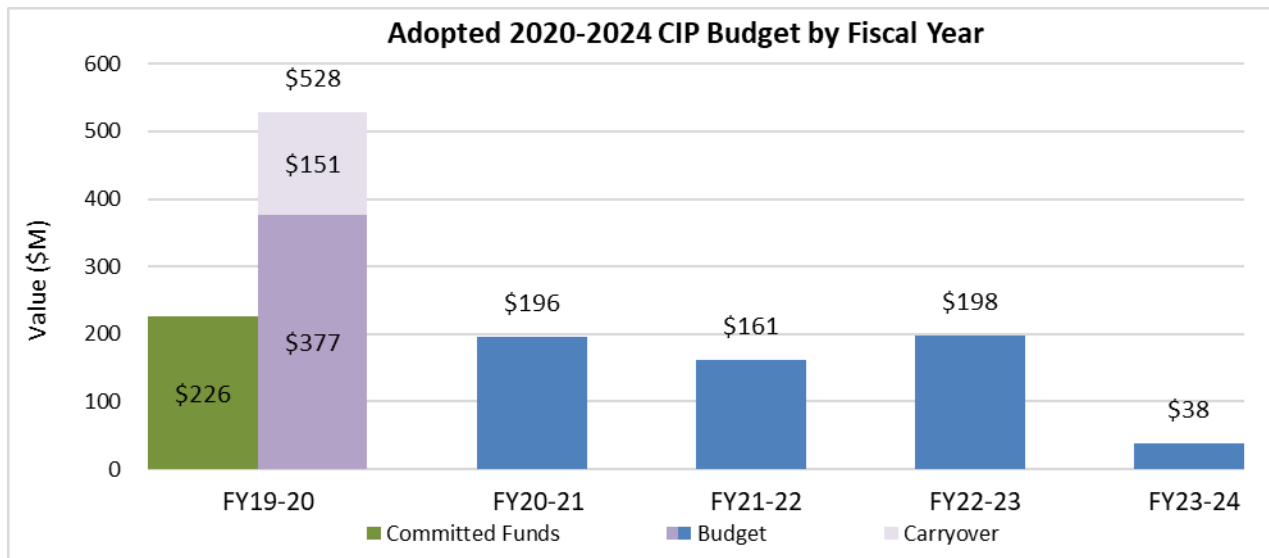

Notes:

Committed Funds: Total of expenditures and encumbrances.

Expenditure: Actual cost expended, either by check to a vendor or through the City's financial system, for expenses such as payroll or for non-personal expenses that do not require a contract.

Encumbrance: Financial commitments such as purchase orders or contracts that are committed to a vendor, consultant, or contractor. An encumbrance reserves the funding within the appropriation and project.

The FY19-20 budget is \$401.5 million, which consists of \$339.6 million in new funds, \$61.9 million in rebudgets. For purposes of this monthly report, the adopted FY19-20 budget is adjusted from \$401.5 million to \$377.2 million due to the exclusion of certain appropriations that are not measured as part of the expenditure KPI. Excluded appropriations include City Hall Debt Service Fund; Clean Water Financing Authority Debt Service Payment Fund; Debt Service Repayment for Plant Capital Improvement Projects (San José only debt service); Equipment Replacement Reserve; Ending Fund Balance; Public Art; City Facilities Emergency Power, and Urgent and Unscheduled Treatment Plant Rehabilitation. Similar adjustments have been made to the budgets for FY20-21 through FY23-24.

Carryover: Encumbrance balances at the end of the previous fiscal year are automatically carried forward to the current fiscal year as carryover funding to pay invoices for approved construction contracts and consultant agreements. FY19-20 carryover is \$151.0 million.

Budget of \$377.2 million and carryover of \$151.0 million totals \$528.2 million for FY19-20.



Fiscal Year 2019-2020 Program Budget Performance

The FY19-20 CIP budget is comprised of approximately \$377.2 million in new and rebudgeted funds, plus encumbered carryover of \$151.0 million, for a total of \$528.2 million. This excludes City Hall Debt Service Fund; Clean Water Financing Authority Debt Service Payment Fund; Debt Service Repayment for Plant Capital Improvement Projects (San José only debt service); Equipment Replacement Reserve; Ending Fund Balance; Public Art; City Facilities Emergency Power; and Urgent and Unscheduled Treatment Plant Rehabilitation items. Overall, the forecast fiscal year-end committed funds exceed the fiscal year-end target by \$40 million.

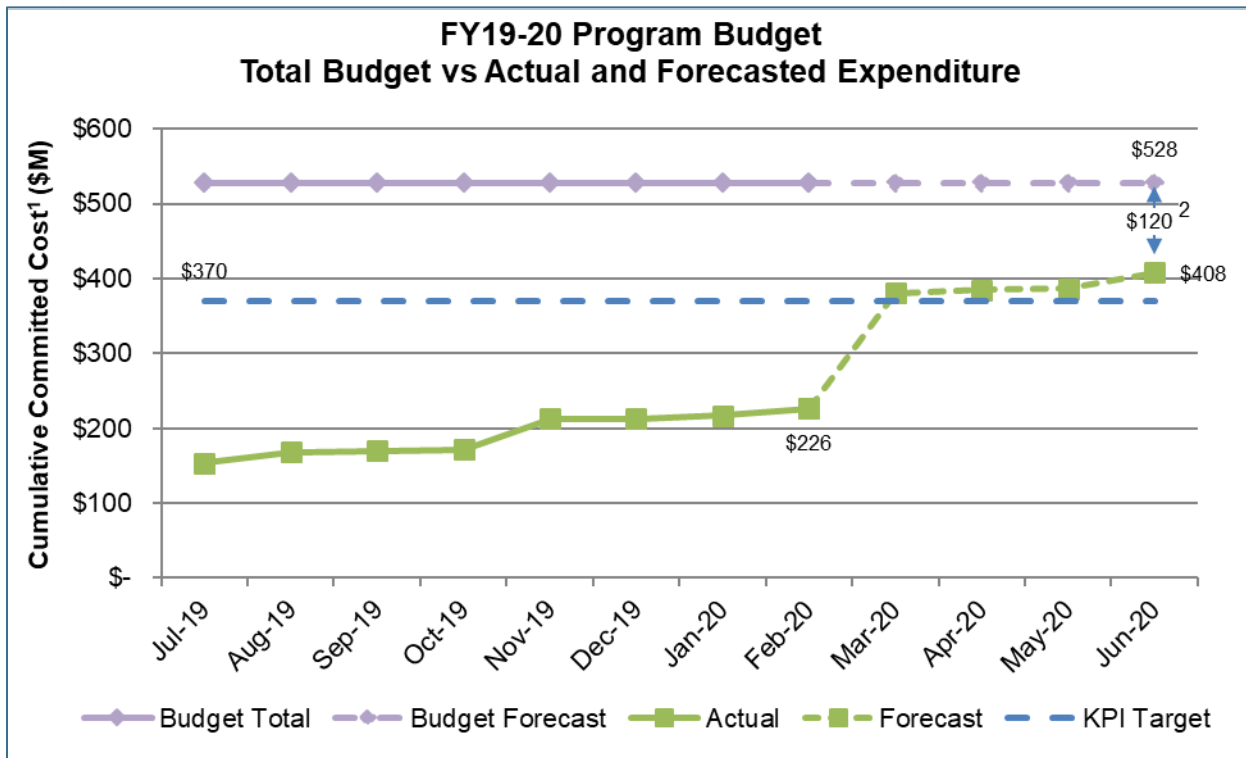

Notes:

1. Committed costs are expenditures and encumbrance balances, including carryover (encumbrance balances from the previous fiscal year).
2. The variance between budget and commitments can be primarily attributed to the following factors:
 - a. Three construction contracts are now anticipated to be awarded in FY20-21 instead of FY19-20, based on updated schedules:
 - i. Filter Rehabilitation Project
 - ii. HVAC Improvements
 - iii. Outfall Bridge and Instrumentation Improvements Project
 - b. Several consultant service orders are not anticipated to be awarded in FY19-20:
 - i. Aeration Tank Rehabilitation Project conceptual through final design
 - ii. Facility Wide Water Systems Improvements Project preliminary engineering and value engineering
 - iii. Flood Protection Project alternatives analysis and conceptual design
 - c. The Yard Piping and Road Improvements Project was divided into multiple design-bid-build phases, resulting in different encumbrance points and values.
 - d. Construction bids for the Nitrification Clarifiers Rehabilitation – Phase 1 and Advanced Facility Control and Meter Replacement - Phase 2 projects came in under budget.
 - e. Several other minor encumbrances for consultant services are either lower than budgeted or are not anticipated to be awarded in FY19-20.
 - f. Several authorized positions remain vacant, resulting in lower personal services expenses than budgeted.



Project Performance Summary

There are currently seven projects in the construction and post-construction phases and an additional 11 projects in feasibility/development, design, bid and award, or design and construction phases (see PDM, page 2). Projects in the construction phase have established cost and schedule baselines and are monitored using the City's Capital Project Management System (CPMS). Green/red icons are included in the table below to indicate whether these projects are on budget and schedule.

Project Performance – Baselined Projects

Project Name	Phase	Estimated Beneficial Use Date ¹	Cost Performance ²	Schedule Performance ²
1. Cogeneration Facility	Design & Construction	Sep 2020	●	●
2. Digester and Thickener Facilities Upgrade	Construction	Nov 2020	◆	◆
3. 96-Inch and 87-Inch Settled Sewage Pipe Rehabilitation	Construction	Jan 2021	●	●
4. Advanced Facility Control & Meter Replacement - Phase 1	Construction	June 2021	●	●
5. Switchgear M4 Replacement and G3 & G3A Removal	Construction	Jul 2022 ³	●	●
6. Blower Improvements	Construction	Sep 2022	●	●
7. Nitrification Clarifiers Rehabilitation – Phase 1	Construction	Jan 2023 ³	●	●

Key:

Cost:	● On Budget	◆ >1% Over Budget	Schedule:	● On Schedule	◆ >2 months delay
-------	-------------	-------------------	-----------	---------------	-------------------

Notes

- Beneficial Use is defined as work that is sufficiently complete, in accordance with contract documents, that it can be used or occupied by the City. Beneficial Use dates are reviewed as part of project schedule reviews.
- An explanation of cost and schedule variances on specific projects identified in this table is provided on page 13.
- The project construction Beneficial Use date will be baselined once the City issues the construction contract NTP letter.



Project Performance – Pre-Baselined Projects

Project Name	Phase	Estimated Beneficial Use Date ¹
1. Headworks	Design and Construction	Jun 2023
2. Digested Sludge Dewatering Facility	Design and Construction	Jan 2024
3. Fire Life Safety Upgrades	Bid/Award	Oct 2022
4. Advanced Facility Control & Meter Replacement - Phase 2	Bid/Award	Jan 2023
5. Outfall Bridge and Instrumentation Improvements	Design	Dec 2021
6. Filter Rehabilitation	Design	Jul 2023
7. HVAC Improvements	Design	Feb 2025
8. Yard Piping Improvements – Phase 1	Feasibility/Development	Nov 2021
9. Storm Drain System Improvements	Feasibility/Development	Sep 2023
10. Facility Wide Water Systems Improvements	Feasibility/Development	Jan 2025
11. Final Effluent Pump Station and Stormwater Channel Improvements	Feasibility/Development	May 2026

Notes

- Beneficial Use is defined as work that is sufficiently complete, in accordance with contract documents, that it can be used or occupied by the City. Beneficial Use dates are reviewed as part of project schedule reviews.



Project Significant Accomplishments

Biosolids Package

Digested Sludge Dewatering Facility Project

- As part of the project's centrifuge performance study, two manufacturers completed their centrifuge demonstrations with RWF digested sludge. The last demonstration will be performed next month.
- CIP & O&M representatives visited East Bay Municipal Utility District and the Union Sanitary District centrifuge facilities to learn more about the conveyor systems they have used.

Digester and Thickener Facilities Upgrade Project

- Contractor Walsh installed new sludge flow equipment concrete pads; electrical conduits; digester roof gas piping; digester gas dome; digester stairway; and digester overflow piping.
- At the new Sludge Screening Building, Walsh completed the HVAC ductwork and the screening bin room rollup door.
- Walsh installed hot water supply and return piping and digester gas piping on the new elevated pipe rack.
- In the DAFT Gallery, Walsh installed a sludge pump and instrument air lines to the last of six pressure flow tanks.

Facilities Package

96-Inch and 87-Inch Settled Sewage Pipe Rehabilitation Project

- The City issued the NTP to contractor Michels Pipeline Construction to start the construction work.

Facility Wide Water Systems Improvements Project

- Consultant Kennedy/Jenks submitted the 50 percent design submittal for an exploratory trenching construction contract that will confirm locations of existing utilities. The final trenching plans are anticipated in May 2020.

Storm Drain System Improvements Project

- The project team received approval to proceed with conceptual design, which is expected to be completed by June.

Liquids Package

Advanced Facility Control and Meter Replacement – Phase 1 Project

- Contractor Overaa replaced and installed three new TSS meters and verified their performance. Next month, the contractor will perform functional testing in the secondary tanks and secondary clarifiers.

Advanced Facility Control and Meter Replacement – Phase 2 Project

- The City received two bids below the engineer's estimate and will recommend Council award the construction contract in June 2020.

Blowers Improvements Project

- Contractor Monterey Mechanical Company completed demolition of all five Tertiary Blower Building air baghouses.

Filter Rehabilitation Project

- The project advanced through Stage Gate 5: Authorization to Bid Stage Gate and anticipates advertising the construction contract in March, with bids due at the end of April.

Headworks Project

- Council approved the amended and restated design-build contract with CH2M. The 100 percent design is expected to be completed in October 2020 with Beneficial Use in June 2023.

Nitrification Clarifier Rehabilitation - Phase 1 Project

- Staff reviewed and returned the Contractor, Overaa's submittals/resubmittals including butterfly valves, stainless steel pipe, flow meters, electrical components, slide gate and telescoping valves, temporary facilities, and controls.

Power and Energy Package

Cogeneration Facility Project

- Design-builder CH2M installed and tested the backup battery system; cleaned and tested the new switchgear; and finished the site paving.



Explanation of Project Performance Issues

Digester and Thickener Facilities Upgrade Project

This project encountered numerous unforeseen conditions at the beginning of construction in 2016, including corroded underground pipe and other obstructions for new building foundations. A temporary reroute system was installed to enable replacement of a 78-inch settled sewage pipeline and junction structure during the 2018 dry season.

In 2017, design modifications were required to address seismic risks, control system changes, additional underground obstructions, pipe anchorage, and new fire department requirements. Discovery of hazardous materials required submittal of an extensive cleanup proposal to the federal Environmental Protection Agency (EPA) for approval. Once mitigation was completed in 2019, the City submitted another report to the EPA that detailed how it met each EPA cleanup permit requirement.

To pay for the additional work to address unforeseen conditions, Council approved a construction contingency increase of \$15 million in November 2017 and another contingency increase of \$25 million in June 2018.

Delays for these conditions have amounted to 273 working days. The original construction completion and Beneficial Use date of September 2019 has been delayed and rescheduled to November 2020. To minimize further delays, the City and contractor have worked together to sequence several tasks so that they could be completed more quickly and efficiently.



Regional Wastewater Facility Treatment – Current Treatment Process Flow Diagram

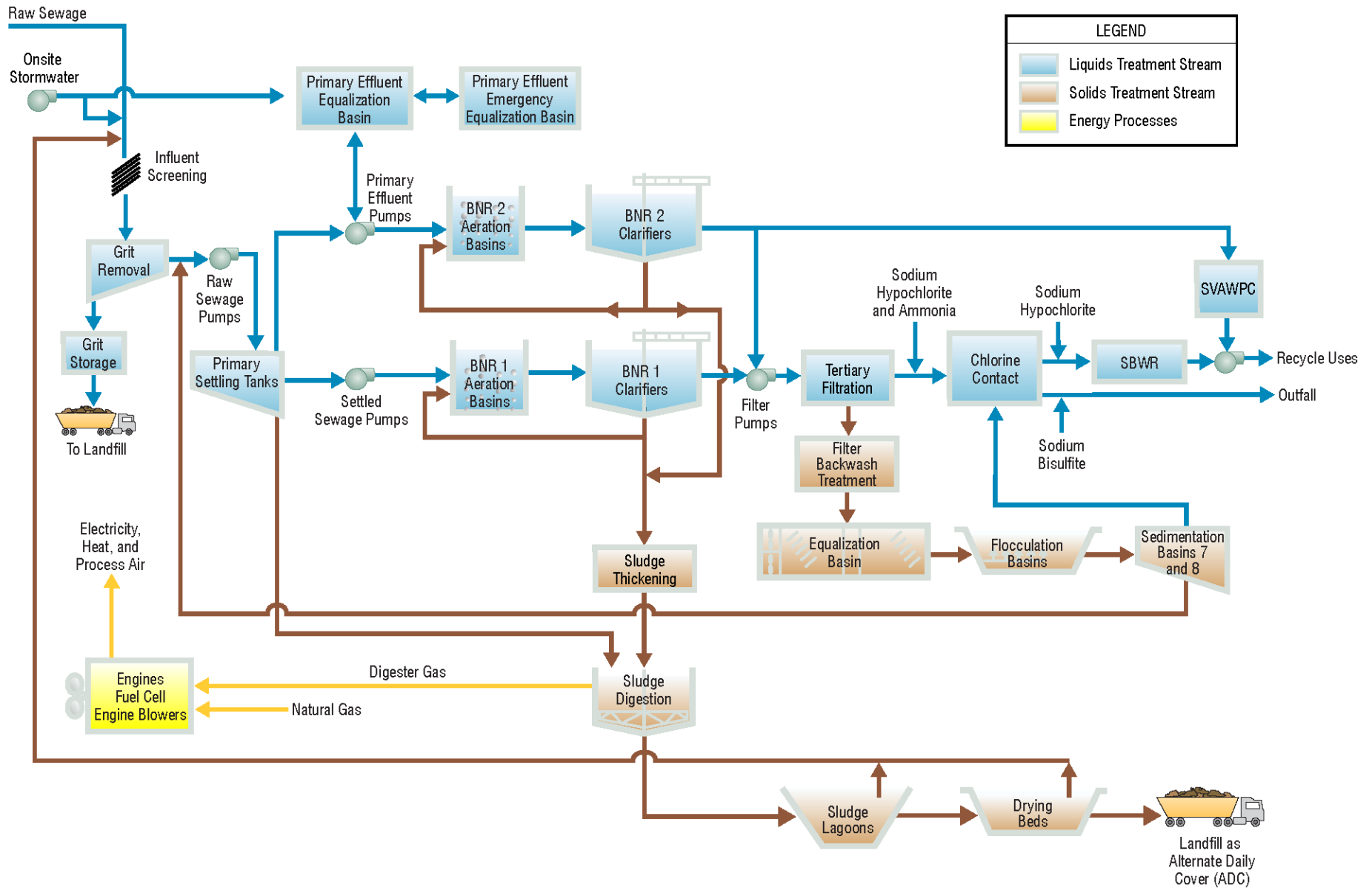

Figure 13 – Current Treatment Process Flow Diagram



Regional Wastewater Facility Treatment – Proposed Treatment Process Flow Diagram

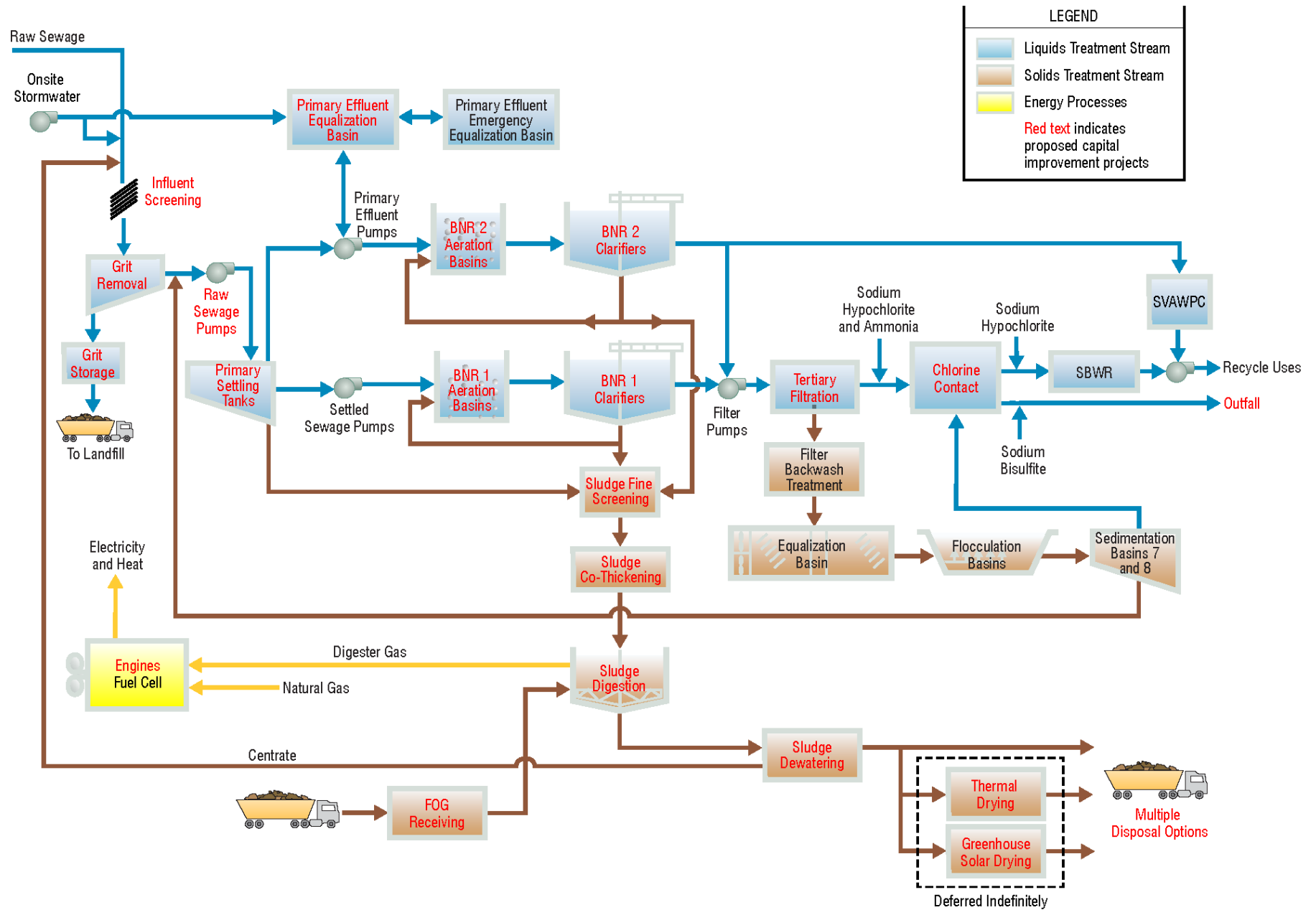

Figure 14 – Proposed Treatment Process Flow Diagram



Active Construction Projects – Aerial Plan

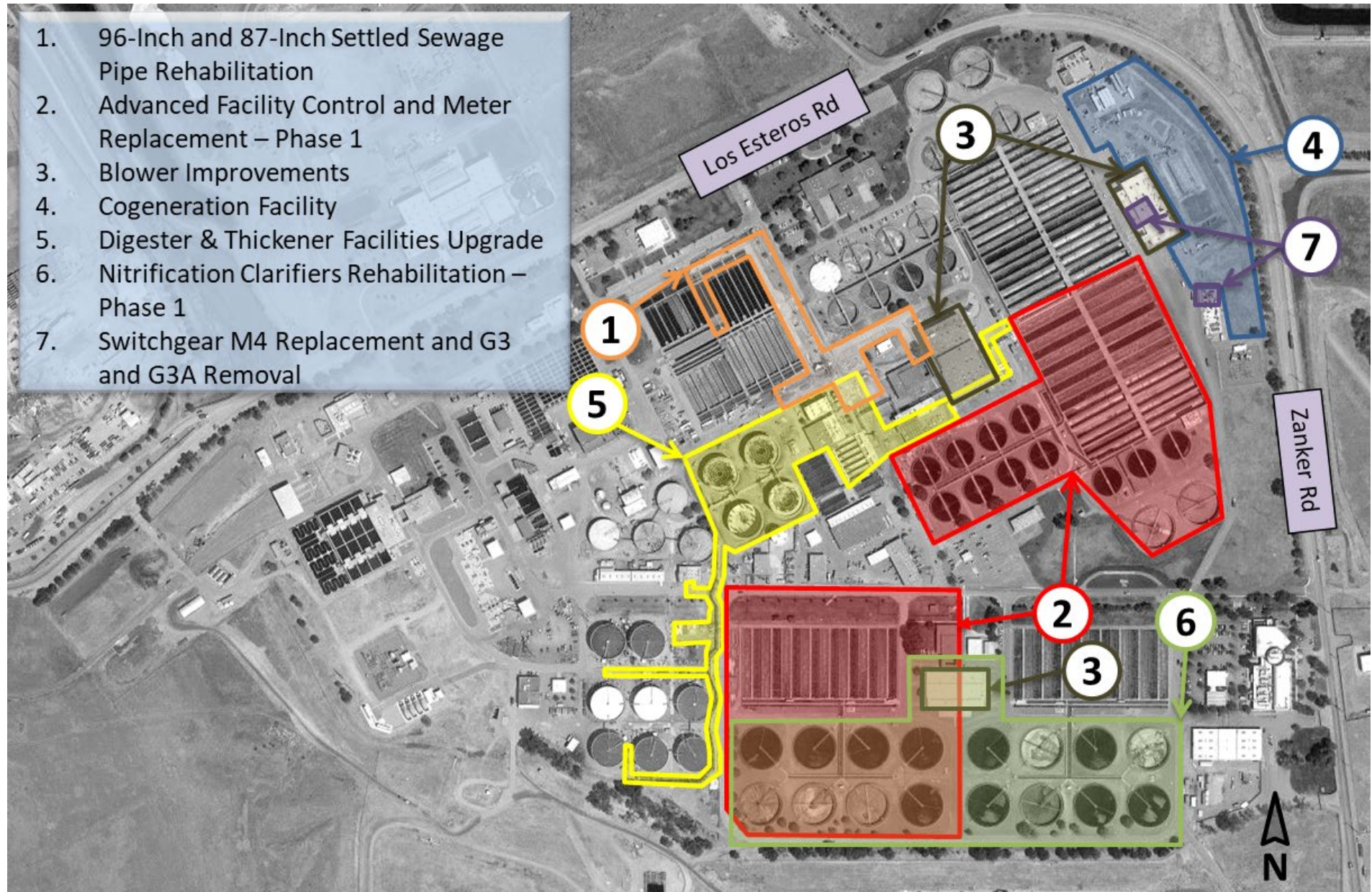
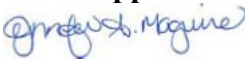

Figure 15: Active Construction Projects

CITY COUNCIL ACTION REQUEST

Department(s): Environmental Services	CEQA: Not a Project, File No. PP17-002, Consultant Services for design, study, inspection, or other professional services with no commitment to future action	Coordination: City Attorney’s Office; City Manager’s Budget Office The Treatment Plant Advisory Committee will consider this item on April 9, 2020	Dept. Approval: /s/ Kerrie Romanow CMO Approval:  4/29/2020
Council District(s): City-Wide			

SUBJECT: SECOND AMENDMENT TO THE MASTER CONSULTANT AGREEMENT WITH CORNERSTONE EARTH GROUP FOR ENVIRONMENTAL SUPPORT SERVICES

RECOMMENDATION:

Approve the Second Amendment to the Master Consultant Agreement with Cornerstone Earth Group, Inc. (Master Agreement) for environmental consulting services, increasing the amount of compensation by \$500,000, for a total agreement not to exceed \$1,500,000.

BASIS FOR RECOMMENDATION:

On April 25, 2017, after a competitive procurement, Council awarded Cornerstone Earth Group, Inc. (Cornerstone) the Master Agreement for Consultant Services for services totaling \$500,000. On September 17, 2019, Council authorized a First Amendment to the Master Agreement increasing the total in the Master Agreement to \$1,000,000. The Environmental Services Department (ESD) has issued twenty three Service Orders to date, totaling \$991,664 for various projects, including groundwater monitoring and contamination investigations at the former Story Road Landfill, soil cleanup oversight for Del Monte Park, environmental support during the installation of a new underground electrical line at Los Lagos Golf Course and a variety of projects at the Regional Wastewater Facility (RWF) including pre-project contamination investigations of Construction Improvement Projects (CIP) projects for Headworks, Filtration, Sludge Dewatering and Nitrification Clarifiers and the regulatorily mandated Regional Wastewater Facility Legacy Lagoons Rehabilitation project and pre-project contamination investigations of Construction Improvement Projects (CIP) projects for Headworks, Filtration, Sludge Dewatering and Nitrification Clarifiers. The \$500,000 capacity of the previous amendment was used much quicker than expected due to the unanticipated design needs of the Legacy Lagoons project.

With this amendment, Cornerstone will continue its work at Story Road Landfill, Los Lagos Golf Course, and the RWF. Its technical expertise provided to these projects, as well as numerous other environmental-related projects, is commensurate with the expertise necessary to continue providing environmental support services in response to regulatory mandates and deadlines. Increasing the compensation on this Master Agreement will allow Cornerstone to continue to provide environmental consulting services for several critical projects in Fiscal Year 2019-20 and 2020-21 including Story Road landfill monitoring and contamination investigations, RWF CIP pre-project soil and groundwater contamination investigations, closure plans for the RWF Legacy Lagoon Rehabilitation, and regulatory assistance.

In addition, ESD provides environmental support to various City Departments and utilizes this contract for those services. There is a strong likelihood that new projects will occur through 2020-21 that will require the support of Cornerstone, such as a new Fire Training Facility and Del Monte Park.

Increasing the Master Agreement's maximum total compensation from \$1,000,000 to \$1,500,000 will allow the City to continue to meet the regulatory requirements and ensure public safety in the most cost effective and timely manner. A one-year extension option in the existing Master Agreement will be exercised to increase the term of the agreement, to expire on June 30, 2021.

Climate Smart San José: The recommendation in this memo has no effect on Climate Smart San José energy, water, or mobility goals.

Commission Recommendation/Input: No commission recommendation or input is associated with this memo.

COST AND FUNDING SOURCE:

Services performed by Cornerstone under this agreement will be authorized by Service Orders. An appropriation is not required for execution of the Master Consultant Agreement but is required for each Service Order authorized under this agreement. The currently projected sources of funding are:

- 512 – San José-Santa Clara Treatment Plant Capital Fund. (RWF projects) \$325,000
- 500 - Water Utility Capital Fund (Los Lagos Golf Course) \$25,000
- 001 – General Fund (Story Road Landfill) \$150,000

Service Orders funded through the San José-Santa Clara Treatment Plant Capital Fund (Fund 512) will have no impact on the San José-Santa Clara Treatment Plant Operating Fund (Fund 513) or the General Fund.

FOR QUESTIONS CONTACT: Jennifer Voccola-Brown, Acting Environmental Sustainability Manager at 408-975-2594



Memorandum

TO: HONORABLE MAYOR
AND CITY COUNCIL

FROM: Kerrie Romanow

SUBJECT: SEE BELOW

DATE: April 30, 2020

Approved

Date

4/30/2020

**SUBJECT: REPORT ON BIDS AND AWARD OF CONTRACT FOR 9115 –
ADMINISTRATION BUILDING ROOF REPLACEMENT PROJECT AT
THE SAN JOSE-SANTA CLARA REGIONAL WASTEWATER FACILITY**

RECOMMENDATION

- a) Report on bids and award of a construction contract for 9115-Administration Building Roof Replacement Project to the low bidder, Stronger Building Services, in the amount of \$590,000, and
- b) Approve a 20 percent construction contingency in the amount of \$118,000.

OUTCOME

Award of this construction contract will allow for the necessary work to complete the Administration Building Roof Replacement Project (Project) at the San José-Santa Clara Regional Wastewater Facility (RWF). Approval of a 20 percent construction contingency will provide adequate funding for any unanticipated work necessary for the completion of the project.

BACKGROUND

The roof of the administration building, at the RWF, is approximately 34,000 square feet in area and includes sections that are between 44 and 58 years of age. The roof has exceeded its useful life and has experienced several leaks within the last few years. There is an urgent need to replace the existing roofing material to avoid any further potential damage to the building's roof framing and interior finishing.

The Project scope includes the removal and replacement of the existing roofing material, insulation, skylights, roof drains, flashing, and various roofing appurtenances that meets current industry standards. The Project also includes asbestos abatement for approximately 4,500 square feet of the roof area.

ANALYSIS

Bids were opened on February 6, 2020, with the following results:

<u>Contractor</u>	<u>Bid Amount</u>	<u>Variance Amount</u>	<u>Over/(Under) Percent</u>
Stronger Building Services (San Leandro, CA)	\$590,000	(\$328,000)	(35.7%)
Courtney Inc. (Livermore, CA)	\$663,896	(\$254,104)	(27.7%)
Andy’s Roofing Company, Inc (San Leandro, CA)	\$748,048	(\$169,952)	(18.5%)
Best Contracting Services, Inc. (Gardena, CA)	\$897,000	(\$21,000)	(2.3%)
Central Roofing Inc. (South San Francisco, CA)	\$910,000	(\$8,000)	(0.9%)
Alcal Specialty Contracting, Inc. (Fremont, CA)	\$912,317	(\$5,683)	(0.6%)
Engineer’s Estimate	\$918,000	---	---
Roofing & Solar Construction Inc. (Novato, CA)	\$1,074,000	\$156,000	17.0%

The low bid submitted by Stronger Building Services is 36 percent under the Engineer’s Estimate. Staff considers the variance to be reasonable for the work involved. The bid documents specified a brand name roofing system that was relied on when determining the engineer’s estimate. Bid documents also allow the contractor to submit an alternate system subject to review and approval by the City. An analysis and comparison between the engineer’s estimate and the bid submitted by the apparent low bidder indicates large price difference between the roofing material, skylights, and insulation. Staff believes that the contractor’s bid is based on a lower cost of products for the above-mentioned materials and expects that the contractor will be providing material substitution requests during the performance of the work. In addition, the variance could also be attributed to the timing of the Project’s advertisement, which was before prospective contractors are typically booked up for the summer construction season.

San José Municipal Code 27.04.050 provides for a standard contingency of 15 percent on renovation projects. This Project is not a renovation project, as it involves removal and replacement (R/R) of approximately 34,000 square feet of existing administration building roofing material that were built in three different phases, between 1961 and 1975. R/R projects may introduce some complexities as there is a need to evaluate and address the integrity of the existing materials that are to remain in place. Regarding this Project, there is limited information on the conditions of the existing roofing materials below the visible roofing layer and any hazardous material component(s) associated with it. During the project design phase, reasonable spot tests were performed which identified approximately 4,500 square feet of roofing area

having hazardous material. Staff believes that there is a high possibility of discovering additional hazardous material during construction since the building was completed at the time when asbestos, lead and other hazardous materials were still being prevalently used in the construction industry. In order to provide adequate funding for any necessary yet unanticipated work, staff recommends a 20 percent construction contingency for this Project.

PROJECT LABOR AGREEMENT APPLICABILITY

A project labor agreement (PLA) is not applicable to this Project as the engineer's estimate is under three million dollars.

LOCAL AND SMALL BUSINESS OUTREACH

The recommended contractor is neither a local nor a small business. On January 15, 2020, the Bidding solicitation went out to 6,225 vendors. Fourteen vendors downloaded the bid documents, six of which were local companies.

CONCLUSION

Based on the bids received, staff considers the bid submitted by the low bidder to be acceptable for the work involved and recommends awarding the construction contract to Stronger Building Services.

EVALUATION AND FOLLOW-UP

No other follow-up action with the Council is expected at this time.

CLIMATE SMART SAN JOSE

This Project replaces the existing roof with an energy efficient roof system. The proposed light colored pvc reflective roof can help lessen the heat from hot roof surfaces that contribute to elevated indoor air temperatures and increased demands on air conditioning that result in higher energy consumptions. The recommendation in this memo aligns with one or more Climate Smart San José energy, water, or mobility goals.

PUBLIC OUTREACH

This Project was advertised on Biddingo.com on January 15, 2020. This memorandum will be posted on the City Council’s Agenda website for the May 19, 2020, City Council meeting.

COORDINATION

This Project and memorandum have been coordinated with the City Manager’s Budget Office, City Attorney’s Office, Planning, Building and Code Enforcement, Finance Department, and Department of Public Works.

COMMISSION RECOMMENDATION/INPUT

This item is scheduled to be heard at the May 7, 2020 TPAC meeting. A supplemental memorandum with the TPAC’s will be included in the May 19, 2020 City Council meeting agenda.

COST SUMMARY/IMPLICATIONS

1.	AMOUNT OF RECOMMENDATION:	\$590,000
	Project Delivery*	\$188,777
	Construction	\$590,000
	Contingency (20%)	<u>\$118,000</u>
	Total Project Costs	\$896,777
	Previous Expenditures	(\$60,514)
	Remaining Project Costs	\$836,263

**Project delivery costs include \$60,514 for project design and construction support services such as material submittals review, response to RFIs, any material substitutions requests, etc., that was performed by the City’s consultant HydroScience Engineers, Inc., and \$128,263 for City construction management and inspection services. The project delivery cost is approximately 32% of the construction cost. The typical range for project delivery of RWF CIP projects is 30 to 60% of construction cost. Please note that the consultant fees of \$60,514 are covered in the San José-Santa Clara Treatment Plant Operating Fund (513), with all remaining costs being covered in the San José-Santa Clara Treatment Plant Capital Fund (512). No additional allocation is needed to proceed with this project.*

2. COST ELEMENTS OF AGREEMENT/CONTRACT:
This is a lump sum contract for \$590,000.

April 30, 2020

Subject: 9115 – Administration Building Roof Replacement

Page 5

3. SOURCE OF FUNDING: 512 – San José-Santa Clara Treatment Plant Capital Fund
513 – San José-Santa Clara Treatment Plant Operating Fund
4. FISCAL IMPACT: This project will have no additional impact on San José-Santa Clara Treatment Operating Fund (513) or the General Fund.
5. PROJECT COST ALLOCATION: In accordance with the recommendations set forth in Capital Project Cost Allocations Technical Memorandum (Carollo Engineers, March 2016), this project will be allocated between the four billable parameters relative to the rolling weighted average distribution of all RWF assets.

BUDGET REFERENCE

The table below identifies the fund and appropriations to fund the contract recommended as part of this memo and remaining project costs, including project delivery, construction, and contingency costs.

Fund #	Appn #	Appn. Name	Total Appn	Amt. for Contract	2019-2020 Adopted Capital Budget Page	Last Budget Action (Date, Ord. No.)
Remaining Project Costs			\$836,263			
512	5690	Plant Infrastructure Improvements	\$1,772,000	\$590,000	V-147	10/22/2019 Ord. No. 30325
Total Current Funding Available			\$1,772,000			

CEQA

Exempt, File No. PP19-074.

/s/
KERRIE ROMANOW
Director, Environmental Services

For questions please contact Napp Fukuda, Assistant Director of Environmental Services, at (408) 635-2039.



Memorandum

TO: HONORABLE MAYOR
AND CITY COUNCIL

FROM: Kerrie Romanow
Matt Cano
Jim Shannon

SUBJECT: SEE BELOW

DATE: April 30, 2020

Approved

Date

4/30/2020

COUNCIL DISTRICT: 4

SUBJECT: REPORT ON BIDS AND AWARD OF CONSTRUCTION CONTRACT FOR 9394 – LEGACY LAGOONS CLEANUP PHASE 1 PROJECT AT THE SAN JOSÉ – SANTA CLARA REGIONAL WASTEWATER FACILITY

RECOMMENDATION

- (a) Adopt a resolution adopting an Addendum to the Environmental Impact Report for the San José-Santa Clara Water Pollution Control Plant Master Plan Project in accordance with the California Environmental Quality Act (CEQA), as amended, and adopting a related Mitigation Monitoring and Reporting Program.
- (b) Report on bids and award of contract for the 9394 – Legacy Lagoons Cleanup Phase 1 Project to the low bidder, Pipe and Plant Solutions, Inc. in the amount of \$4,901,796, and approval of a 15 percent contingency in the amount of \$735,270.
- (c) Adopt the following 2019-2020 Appropriation Ordinance Amendments in the San José-Santa Clara Treatment Plant Capital Fund:
 - 1. Decrease the Support Building Improvements appropriation to the Environmental Services Department by \$8,037,066; and
 - 2. Establish the Legacy Lagoons Biosolids Remediation appropriation to the Environmental Services Department in the amount of \$8,037,066.

OUTCOME

Award of the construction contract to Pipe and Plant Solutions, Inc. will allow for construction and completion of the 9394 – Legacy Lagoons Cleanup Phase 1 Project (Project) at the San José-Santa Clara Regional Wastewater Facility (RWF or Facility). The Project will allow the City of San José (City) to comply with the Order No. R2-2019-0026 (Order) from the San Francisco Bay Regional Water Quality Control Board (Regional Water Board) and facilitate the advancement of the South Bay Shoreline Levee Project led by the U.S. Army Corps of Engineers

(Corps). Approval of a fifteen percent contingency will provide funding for any unanticipated work that is necessary for the proper completion of the Project.

BACKGROUND

From 1962 to 1974, the RWF accumulated the residuals from its solids treatment process (biosolids) in a series of 25 bermed lagoons (Legacy Lagoons) located north of the RWF's main operational area. (See Attachment A.) No additional material has been placed in these lagoons since 1974. The biosolids were cleaned and relocated from Lagoons L-4 and L-8 to Lagoon L-12 in 1992 and 1994. Lagoon L-8 has been used by the San José Police Department Bomb Squad for explosives detonation and training purposes for the region. The remaining 23 inactive lagoons cover 168-acres and contain a total of approximately 750,000 cubic yards of biosolids.

During the period the lagoons were actively used, the Facility treated waste from industrial activities that were not yet subject to pretreatment requirements of the 1972 Clean Water Act. Sampling and analysis of the legacy biosolids over the last 30 years has characterized the biosolids material as potentially hazardous waste under California law due to concentrations of cadmium, lead, and chromium that exceed disposal thresholds. As part of the San José/Santa Clara Water Pollution Control Plant Master Plan Environmental Impact Report, adopted on November 19, 2013, the City recognized and approved the remediation of the inactive Legacy Lagoons. Once remediation of the inactive Legacy Lagoons is completed, most of the area would become available for either future operational or capital use.

In August 2019, the Regional Water Board issued Order No. R2-2019-0026 (Order) which mandated the City as Administrator of the RWF to remediate the inactive Legacy Lagoons by November 1, 2023. The selected and approved approach is to consolidate and cap the biosolids into a smaller footprint within the project area. In addition, the Order requires prioritization of the cleanup and closure of lagoons L-16 to L-19 by January 1, 2021 to meet the aggressive timeline and realignment of the adjacent South Bay Shoreline Levee Project (Shoreline Project) led by the Corps and sponsored by the Santa Clara Valley Water District (Valley Water) and California State Coastal Conservancy.

Pursuant to the Order, the Project will remove the biosolids from lagoons L-16 to L-19 by January 1, 2021, consolidating and capping the material in other designated lagoons.

To meet the Order's deadline, the design for this project was placed on an expedited schedule and advertised on February 26, 2020. Construction is scheduled to commence in July 2020 with substantial completion in December 2020.

ANALYSIS

Bids were opened on March 26, 2020, with the following results:

<u>Contractor</u>	<u>Bid Amount</u>	<u>Variance Amount</u>	<u>Over/ (Under) Percent</u>
Pipe and Plant Solutions, Inc. (Oakland)	\$4,901,796	(\$48,204)	(1)
Engineer’s Estimate	4,950,000	---	---
Pacific States Environmental Contractors, Inc. (Dublin)	5,845,300	895,300	18
Granite Construction Company (Santa Clara)	6,737,068	1,787,068	36

The low bid submitted by Pipe and Plant Solutions, Inc. is 1 percent under the Engineer’s Estimate. Staff considers this reasonable for the work involved.

Pipe and Plant Solutions, Inc. has been in the construction business for over 9 years and has done numerous projects for public agencies in California, including the City and County of San Francisco, East Bay Municipal Utility District, San Francisco Public Utility Commission, and the San José – Santa Clara Regional Wastewater Facility.

San José Municipal Code Section 7.04.050 provides that, except where Council approves a higher contingency amount, the contingency for all public works contracts (other than those involving the renovation of a building or buildings) cannot exceed ten percent of the total contract amount. Because this project is within an environmentally sensitive area which is a natural habitat of the endangered salt marsh harvest mouse, unknown existing site conditions largely due to age of the Facility, and has a short construction window, staff recommends a contingency of 15 percent to account for natural habitat management and for any unanticipated work necessary for the proper completion of the project. The funds budgeted for this project are sufficient to provide for the recommended contingency.

Pursuant to the Order of the Health Officer of the County of Santa Clara (Health Order), issued on March 31, 2020, Section 13.f.v.4, the City has reviewed and determined that this project is required to support Essential Governmental Functions, and therefore, will be continued while the Health Order is in effect.

Project Labor Agreement Applicability

The Director of Public Works determined that a project labor agreement (PLA) is applicable to this project because the engineer’s estimate is over three million dollars and the project does not meet any of the exemptions outlined in the PLA agreement.

Local and Small Business Outreach

In order to facilitate small and local business participation on this project, the following actions were taken: (1) during the design, the project engineers separated the following items for subcontracting opportunities: pickleweed removal, silt fence, construction survey & staking, and erosion control hydro seed in order to facilitate the ability for more local contractors to bid on the project; and (2) procurement staff outreached suppliers through Biddingo with 9,381 emails.

Pipe and Plant Solutions, Inc. and their two subcontractors, Proven Management, Inc. and Pronesti Environmental Inc. are not local Santa Clara County businesses.

CONCLUSION

Based on staff's evaluation of the bids, staff considers the low bid acceptable and recommends awarding the construction contract for the Project to Pipe and Plant Solutions, Inc.

EVALUATION AND FOLLOW-UP

The City will update the Treatment Plant Advisory Committee (TPAC) and the San José and Santa Clara city councils before the anticipated property transaction of Lagoons L-16 to L-19 for the realignment of the Shoreline Project. Any final property transaction will require approval by both the San José and Santa Clara city councils. The planned second phase will relocate the biosolids material in the remaining inactive Legacy Lagoons to the consolidation area and install a permanent cap. Construction for this second phase is anticipated to start as early as Summer 2021. Staff will return to TPAC and council for the award of phase two construction work.

A progress report on this project will be included in the semiannual updates of the RWF capital projects to TPAC, Transportation and Environment Committee, and the Council.

CLIMATE SMART SAN JOSÉ

The recommendation in this memo has no effect on Climate Smart San José energy, water, or mobility goals.

HONORABLE MAYOR AND CITY COUNCIL

April 30, 2020

Subject: 9394 – Legacy Lagoons Cleanup Phase 1 Project

Page 5

PUBLIC OUTREACH

To solicit contractors, this project was advertised on Biddingo.com on February 26, 2020. The complete bid package and project information for all Department of Public Works construction projects are available on Biddingo.com for interested contractors, contractor organizations, and builders' exchanges. This memorandum will be posted on the City's Council Agenda website for the May 12, 2020 City Council Meeting.

COORDINATION

This project memorandum has been coordinated with the City Attorney's Office, Finance Department, and the Planning, Building and Code Enforcement Department.

COMMISSION RECOMMENDATION/INPUT

This item is scheduled to be heard at the May 7, 2020 TPAC meeting. A supplemental memo with TPAC's recommendation will be included in the amended May 12, 2020 City Council meeting agenda.

FISCAL/POLICY ALIGNMENT

This project is consistent with the Plant Master Plan objectives of flood control (Shoreline project), efficient operations (maximizes long-range efficient use of the RWF's existing facilities and reduces the footprint of the biosolids treatment area), and habitat (reduces long-term threat to habitat).

COST SUMMARY/IMPLICATIONS

1. AMOUNT OF RECOMMENDATION/COST OF PROJECT:

Project Delivery	\$2,400,000 *
Construction	4,901,796
Contingency (15%)	<u>735,270</u>
Total Project Costs	<u>\$8,037,066</u>

* Project Delivery includes \$1,105,000 for Design Service and \$1,295,000 for Construction Management and Inspection Services.

2. COST ELEMENTS OF AGREEMENT/CONTRACT:

Mobilization	\$280,000
Stormwater Pollution Prevention Plan	586,556
Demolitions	881,800
Survey	150,000
Excavation	1,504,900
Site Grading	1,387,840
Erosion Control	<u>110,700</u>
TOTAL AGREEMENT/CONTRACT AMOUNT	<u>\$4,901,796</u>

3. SOURCE OF FUNDING: 512-San José-Santa Clara Treatment Plant Capital Fund. Appropriation actions for 2019-2020 are recommended to shift funding to a new appropriation for Legacy Lagoons Cleanup from the Support Building Improvements appropriation. Construction award for the HVAC Improvements Project, under the Support Building Improvements appropriation, is now anticipated to be deferred to 2022-2023, to better align the timing of construction with available construction management resources. New funds have been programmed in the 2021-2025 Proposed Capital Improvement Program (CIP) for the HVAC Improvements Project.

4. FISCAL IMPACT: This contract will have no additional ongoing impact on the San-José-Santa Clara Treatment Plant Operating Fund (Fund 513) or the General Fund.

5. PROJECT COST ALLOCATION: In accordance with the recommendations set forth in Capital Project Cost Allocations Technical Memorandum (Carollo Engineers, March 2016), this project will be allocated between the four billable parameters relative to the rolling weighted average distribution of all RWF assets.

BUDGET REFERENCE

The table below identifies the fund and appropriations to fund the contract recommended as part of this memo and remaining project costs, including project delivery, construction, and contingency costs.

Fund #	Appn #	Appn. Name	Current Total Appn	Recommended Appn Action	Amt. for Contract	2019-2020 Adopted Capital Budget Page	Last Budget Action (Date, Ord. No.)
512	New	Legacy Lagoons Biosolids Remediation		\$8,037,066	\$4,901,796	N/A	N/A
512	7681	Support Building Improvements	\$14,552,000	(\$8,037,066)	N/A	V-141	06/18/2019 Ord. No. 30286

CEQA

Addendum to the Environmental Impact Report for the San José/Santa Clara Water Pollution Control Plant Master Plan (SCH# 2011052074), Legacy Biosolids Lagoons Site Cleanup, File No. ER20-007.

/s/
 KERRIE ROMANOW
 Director, Environmental Services Department

/s/
 MATT CANO
 Director, Public Works Department

 JIM SHANNON
 Budget Director

For questions, please contact Michael O’Connell, Deputy Director, Public Works Department, at (408) 535-8300.

Attachment A: Location Map

Attachment A

9394 - Legacy Lagoons Cleanup Phase 1 Project



LOCATION MAP

N.T.S.



Memorandum

TO: TREATMENT PLANT ADVISORY
COMMITTEE (TPAC)

FROM: Kerrie Romanow
Kim Walesh

SUBJECT: UPDATE POND A-18 SALE

DATE: April 30, 2020

INFORMATION

This memo is an informational update in response to TPAC's request for regular Pond A-18 sale updates. On February 13, 2020, staff informed the Treatment Plant Advisor Committee (TPAC) of an offer from Valley Water to purchase Pond A-18 and related easements. TPAC recommended that staff reject the offer and negotiate for a sale price that reflects the Pond A-18 fair market value and associated impacts the project places on the Regional Wastewater Facility (RWF).

Staff also coordinated the Pond A-18 matter with the City of Santa Clara, as co-owner of the RWF. On March 5, 2020, City of San José staff presented two memoranda to the San José City Council. The first memorandum presented to Council reflected TPAC recommendation to direct the City Manager to continue to negotiate with Valley Water in matters related to the Sale of Pond A-18, but not execute an agreement until presented to TPAC and the City of Santa Clara in addition to the San José City Council. The San José City Council approved the recommendation. The second memorandum discussed compliance with the State Surplus Land Act requirements and made recommendation consistent with a potential sale of RWF land to Valley Water. Again, the San José City Council approved the staff recommendation.

Per the direction of TPAC, City of San José and City of Santa Clara staff collaborated on a counteroffer position, delivered to Valley Water on March 6. Staff countered at \$22,477,000 for the fair value of Pond A18 and payments to reasonably offset the additional operational and capital cost impacts to the RWF resulting from the Shoreline Levee Project. This counteroffer does not include the value of project easements to be transferred as final easement requirements are not defined by Valley Water at this time.

	<i>Cost</i>	<i>Valley Water Offer</i>	<i>Staff Counteroffer</i>
Pond A18	\$13,268,000	\$13,500,000	\$13,500,000
North Gate Repair	\$440,000	\$1,400,000	\$1,400,000
South Gate Repair	\$16,667	\$877,000	\$877,000
Betterments to prepare levee for Regional Water Facility to connect to the final effluent pump station project (estimated)	\$0	\$3,000,000	\$3,000,000
Additional cost (inefficiencies) of 2-phased cleanup of Legacy Lagoons	\$0	\$1,700,000	\$1,700,000
Perimeter security fence and gates to isolate Regional Water Facility (estimated)	\$0	\$1,000,000	\$1,000,000
Compensatory mitigation (estimated split)	\$0	\$1,000,000	\$1,000,000
Total	\$13,724,667		\$22,477,000

Valley Water delivered a response to the counteroffer to San José and Santa Clara staff on April 21, 2020. This response is currently being analyzed and staff will return with a recommendation. In their counteroffer, Valley Water recommended that the City of San José obtain its own independent appraisal to substantiate the fair market value for the property. City staff will proceed with obtaining an appraisal, as recommended, and will do so as expeditiously as possible given the impacted timeline of this transaction.

City of San José and City of Santa Clara staff will continue to coordinate in ongoing negotiations. Negotiated terms of a sale would be brought to TPAC prior to final approval of the San José and Santa Clara city councils.

/s/
 KERRIE ROMANOW
 Director, Environmental Services

/s/
 KIM WALES
 Deputy City Manager
 Director of Economic Development

For questions, please contact Jennifer Voccola-Brown, Sustainability and Compliance Division Manager, at (408) 975-2594 or Nanci Klein, Assistant Director of Economic Development, Director Real Estate, at 408-535-8184.

San Francisco Bay Regional Water Quality Control Board

Sent via email: no hard copy to follow

April 23, 2020

Mr. Dave Sykes
City Manager
City of San Jose
200 East Santa Clara St.
San Jose, CA 95113

Ms. Deanna J. Santana
City Manager
City of Santa Clara
1500 Warburton Ave.
Santa Clara, CA 95050
manager@santaclara.gov

Subject: Requirement to clean up existing legacy biosolids ponds at the San Jose Regional Wastewater Facility and opportunity to coordinate with the South Bay Shoreline Project

Dear Mr. Sykes and Ms. Santana:

I want to start by thanking you both for helping to protect the Bay Area from the spread of COVID-19. I also appreciate that as local officials you are focusing on the challenge of planning for the next phase of the effort. I feel, however, that I need to send this letter to help resolve apparent confusion on behalf of the San Jose Regional Wastewater Facility (RWF) partners regarding the required cleanup of legacy biosolids ponds at the RWF (Cleanup Project) and to reinforce discussions we have had with RWF partners and representatives since 2017. It details the opportunity provided by the adjacent South Bay Shoreline Protection Project (Shoreline Project) to reduce the Cleanup Project's costs, including costs to mitigate for the cleanup-associated disturbance of wetlands. In short, the collaborative effort we have been pursuing is the proverbial win-win scenario that allows all parties to share credit for helping to protect critical water infrastructure and disadvantaged communities in the South Bay from the effects of anticipated sea level rise, and for facilitating restoration of the Bay, while also obtaining substantial cost savings. For the Cleanup Project, that benefit could be in excess of \$25 million. We are concerned that, rather than recognizing those benefits, the RWF partners are seeking Shoreline Project funds to offset Cleanup Project costs, with potentially significant impacts to the feasibility of the Shoreline Project and potentially substantial, but not fully recognized, increases to Cleanup Project costs.

JIM McGRATH, CHAIR | MICHAEL MONTGOMERY, EXECUTIVE OFFICER

Discussion

The Water Board has required the Cleanup Project due to the ongoing threat to environmental health posed by the legacy biosolids, and a lack of voluntary cleanup by the RWF over a period of decades, since the ponds' use ceased in 1974. Cleanup Project timelines are set forth in the site cleanup requirements order issued by the Water Board to the RWF (Cleanup Order),¹ and are intended to ensure timely and efficient cleanup, while providing appropriate flexibility for the RWF to complete project planning, design, and implementation. The timelines reflect work already completed by the RWF, including a 1994 geotechnical report and a 2002 disposal alternatives analysis.² In short, the requirement to clean up the legacy biosolids ponds in a timely fashion exists without regard to whether RWF elects to continue working in collaboration with the Shoreline Project. Nevertheless, we intentionally and in coordination with all parties crafted the Order to recognize the opportunity for the Cleanup Project to substantially reduce costs by coordinating with the Shoreline Project, and for that reason include information and flexibility to facilitate that coordination, while recognizing that it is optional.³

More specifically, the Cleanup Project has an opportunity to significantly reduce cleanup-associated wetland mitigation costs. This would be done by coordinating the cleanup with construction of an inboard alignment for the Shoreline Project that is easier and potentially cheaper for that project to build. The inboard alignment would also restore approximately 25 acres of San Francisco Bay—a rare opportunity to restore the Bay Area's eponymous crown jewel water. Alignment of shoreline flood protection in manner that accommodates sea level rise and habitat restoration is consistent with the stated goals of our [project to amend our Basin Plan](#) and is responsive to various studies including the recently released [Adapting to Rising Tides](#). The Water Board would recognize the RWF's important collaborative role in helping to achieve the Bay restoration by allowing the RWF to share the wetland mitigation credit for it. In addition to the wetland creation credit the RWF would recognize from the Bay restoration, the Water Board would allow the RWF to fulfill the Cleanup Project's remaining wetland mitigation obligation by re-creating wetlands at the RWF at a 1:1 ratio, an unusually low ratio that would recognize the high value of restoring the Bay. Thus, by coordinating with the Shoreline Project, the RWF would achieve a substantial reduction in the Cleanup Project's wetland mitigation costs. As discussed below, this appears to be a benefit to the Cleanup Project that exceeds \$25 million, based on current costs for alternative mitigation approaches.

As noted in the Cleanup Order, sharing credit for the Bay restoration "...would substantially reduce the [RWF's] financial obligation related to compensatory mitigation by minimizing the costs associated with implementing large-scale compensatory mitigation, including land acquisition, design, permitting, construction, and post-construction operation and maintenance."⁴ That reduction is in comparison to the likely potential costs associated with the other mitigation options. There may also be opportunities for coordination with respect to reusing less-contaminated portions of the legacy biosolids lagoons as foundation fill in the Shoreline Project's levee core, which could reduce the RWF's costs for disposal.

The Cleanup Project will disturb an estimated 50 acres of seasonal wetlands at the cleanup site. Pursuant to applicable regulation and policy, the Cleanup Project must appropriately avoid and minimize impacts. Where avoidance and minimization are impracticable, the project must complete compensatory mitigation to address the remaining impacts. Typically, compensatory

¹ Site Cleanup Requirements Order No. R2-2019-0026, issued August 27, 2019.

² Cleanup Order Finding 8, Closure Options.

³ For example, Cleanup Order Task 2 notes "if the [RWF] coordinates with the Shoreline Project, the Closure Plan shall ensure that Ponds 16-19 are cleaned up sufficient to convey them to the Corps by January 1, 2021, so the land may be acquired for use in the Shoreline Project by May 2021, or as otherwise consistent with the Shoreline Project's construction and land acquisition schedule" (emphasis added).

⁴ Cleanup Order Finding 14, "Opportunities for Coordination."

mitigation amounts are greater in terms of total area than the area impacted because of factors including: uncertainty in the establishment of mitigation wetlands; time delays in the establishment of mitigation wetlands relative to when impacts occur; and the potential for mitigation to be either out-of-kind or off-site. The Water Board's *San Francisco Bay Basin Water Quality Control Plan* directs that mitigation for impacts should be in-kind, or as close to in-kind, as possible, and as close to the impact site as possible. When they are not, the Water Board requires greater amounts of mitigation.

If the RWF partners are unable to participate in the collaborative project for Bay restoration, then the Cleanup Project is likely to incur the normal wetland mitigation costs for a project of this size and in this location. In place of the Shoreline Project' high-value restoration with an upland alignment, the RWF could re-create on-site a substantially greater area of lower-value wetlands, and uplands sufficient to contribute water to support those wetlands, and preserve those areas in perpetuity, precluding alternative future land uses. The RWF could also complete mitigation off-site—that is, obtain sufficient land nearby on which to create mitigation wetlands and preserve associated upland, or purchase mitigation credits from an available mitigation bank. Mitigation completed nearby could require creation of on the order of 100 acres of compensatory wetlands to mitigate for impacts due to uncertainty, delays in establishment, and distance. Alternately, there is one bank with available mitigation credits and a service area that includes the Cleanup Project, the San Francisco Bay Wetland Mitigation Bank in Redwood City. Mitigation at that bank is selling for more than \$1 million per acre; however, the bank does not have the necessary 50+ acres of credit available. Based on that potential cost, the value to the RWF of sharing in credit for 25 acres of Bay restoration—which would reduce the Cleanup Project's wetland mitigation obligation by at least 25 acres—would exceed \$25 million.

Summary

The Cleanup Order requires that the RWF address the threat to environmental health posed by the legacy biosolids ponds via cleanup. The Water Board asks that you seriously consider the significant opportunities that could be realized by the RWF if it is able to collaborate with the Shoreline Project in the restoration of the Bay and protection of critical water infrastructure and disadvantaged communities that are vulnerable to climate change. We appreciate the substantial efforts by the RWF partners and look forward to continuing to coordinate with you on the cleanup.

Please contact me or Keith Lichten of my staff with any questions on this matter or to discuss it further.

Sincerely,

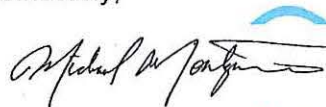

Digitally signed by Michael
Montgomery
Date: 2020.04.23 18:11:30

Water Boards 07:00'

Michael Montgomery
Executive Officer

Cc: Staff to Senator Dianne Feinstein:
Ms. Alexis Segal, Alexis_Segal@feinstein.senate.gov
Staff to Congressman Ro Khanna:
Ms. Lakeisha Bryant, Lakeisha.Bryant@mail.house.gov
Mr. Kevin Fox, kevin.fox@mail.house.gov
Senator Bob Wieckowski, Senator.Wieckowski@senate.ca.gov
Mr. Stu Townsley, U.S. Army Corps of Engineers, Edwin.S.Townsley@usace.army.mil
Ms. Norma Camacho, CEO, Valley Water, ncamacho@valleywater.org
Mr. Sam Schuchat, EO, State Coastal Conservancy, sam.schuchat@scc.ca.gov

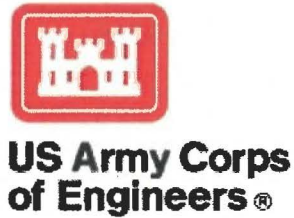

April 3, 2020

Mr. Keith H. Lichten
Chief Watershed Management Division
SF Bay Regional Water Quality Control Board
1515 Clay St., Suite 1400
Oakland, CA 94612

SUBJECT: Regional Water Quality Control Board Cleanup Order to Regional Wastewater Facility Legacy Biosolid Ponds

Dear Mr. Lichten:

The U.S. Army Corps of Engineers (USACE) and Non-Federal Sponsors, California State Coastal Conservancy (CSCC) and Santa Clara Valley Water District (Valley Water), are interested in the environmental benefits (restoring additional acres to tidal influence) and cost savings (due to reduced imported fill by reusing berms material from legacy biosolid ponds area) associated with the South San Francisco Bay Shoreline Project (Shoreline Project) Reaches 4/5 levee alignment change near City of San Jose's (CSJ) legacy biosolid ponds. We have been trying to work with CSJ staff to consider the levee alignment change.

CSJ staff continues to express a belief that because of the proposed levee alignment change, they now have to proceed with the cleanup of the legacy biosolid ponds earlier than they had anticipated and that they would lose mitigation credits for inclusion of some of the legacy ponds to the Shoreline Project. As a result, they have requested financial compensation for expediting and cost inefficiency for cleanup of the legacy biosolid ponds in two phases and for a loss of mitigation credit.

We simply cannot afford additional costs to the Shoreline Project and are trying to find ways to reduce the project cost. Our understanding is that implementing the recommended levee alignment change will not result in additional cost to the CSJ. We request that the Regional Board make it clear to CSJ that: (1) the cleanup of the legacy biosolid ponds is a requirement separate from Shoreline Project nor is accelerated by the Shoreline Project; (2) there are potential mitigation cost savings to CSJ for their cleanup by working with the Shoreline Project; and (3) the expected requirements of the CSJ should the alignment change not occur.

We appreciate Regional Board staff's support of the Shoreline Project. Please contact Mr. Neil Hedgecock of USACE staff at (415) 503-6728.

Sincerely,



Melanie Richardson, P.E.
Chief Operating Officer
Watersheds
Valley Water

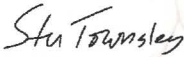

Digitally signed by
TOWNSLEY, EDWIN, STUART.1255
227412
Date: 2020.04.06 12:03:15 -07'00'

E. Stu Townsley
Deputy District Engineer
U.S. Army Corps of Engineers
for Project Management



Sam Schuchat
Executive Officer
California State Coastal
Conservancy

April 16, 2020

Brett McClure
Safety Committee Chairman
IBEW Local 332
2125 Canoas Garden Ave, Ste 100
San Jose, CA 95125

SAN JOSÉ/SANTA CLARA TREATMENT PLANT ADVISORY COMMITTEE

San José City Hall
200 E. Santa Clara St.
San Jose, Ca 95113

Dear Colleagues,

I am writing to urge you to consider temporarily shutting down the construction work being completed at the co-generation facility at the San Jose/Santa Clara Wastewater treatment plant. As an electrician in the field, I can tell you that it is impossible to comply with Cal/OSHA standards with regards to coronavirus safety and continue with this job.

We are told to stay six feet from each other yet terminating and pulling wire into electrical panels requires physical closeness of two feet or less. Without such teamwork, tasks become much more difficult and time-consuming. Also, construction site noise requires closer proximity just to communicate with each other.

We are then told to wear masks, but the masks provided were inadequate. They are ill-fitting, causing loss of vision due to obstruction and fog. Clarity of vision is key to jobsite safety. Out of frustration and necessity, masks are then removed—eliminating their intended purpose. Construction work requires regular hydration breaks, further necessitating mask removal.

We were told we can't be transported in a van or even an ATV from the required parking lot over a ¼ mile from the jobsite, for fear of exposing many workers in a confined space. Interestingly, once time spent walking to the jobsite became billable, that protocol changed. Now we are allowed to carpool as long as we wear masks—the same masks that don't fit well in the first place. Aerosols and respiratory droplets get around ill-fitting masks easily enough.

In short, working conditions, lack of proper protection, and inconsistent practices are potentially exposing us all to the coronavirus. I urge you to halt this project until this crisis passes. This job can wait until our lives are no longer at risk.

Respectfully,

A Concerned Worker

San Jose / Santa Clara Treatment Plant Advisory Committee
San Jose City Hall
200 E. Santa Clara St.
San Jose, CA 95113

17 APR 2020 PM 7 1

OAKLAND CA 945



0019130003

0019130003



Memorandum

TO: HONORABLE MAYOR
AND CITY COUNCIL

FROM: Kerrie Romanow
Matt Cano

SUBJECT: SEE BELOW

DATE: April 13, 2020

Approved

Date

4/13/2020

INFORMATION

**SUBJECT: SAN JOSE-SANTA CLARA REGIONAL WASTEWATER FACILITY
CAPITAL IMPROVEMENT PROGRAM SEMIANNUAL STATUS
REPORT**

The purpose of this semiannual status report is to provide an update on the implementation of the Capital Improvement Program (CIP) at the San José-Santa Clara Regional Wastewater Facility (RWF) by highlighting key accomplishments during the first half of fiscal year 2019-2020 to the Transportation and Environment Committee (T&E), the Treatment Plant Advisory Committee (TPAC), and Council.

At the time of this report, staff is evaluating the status of projects and ability to move forward during the countywide shelter-in-place order due to the novel coronavirus (COVID-19). The order was not in effect during this reporting period (July to December 2019), which is why it is not addressed in this report. A separate informational memorandum will be issued in the next few weeks with the current status of capital projects at the RWF.

BACKGROUND

The San José and Santa Clara City Councils adopted the Plant Master Plan (PMP) in November 2013 and December 2013, respectively. The PMP identified more than 100 capital improvement projects totaling over \$2.1 billion to be implemented at the RWF over the next 30 years. A validation process was completed in early 2014 to update and prioritize the recommended PMP projects and additional gap projects into 33 projects to be initiated over 10 years. Beginning in fiscal year 2014-2015, the validation process was used to inform the five-year CIP and ten-year funding strategy. The 2020-2024 adopted CIP includes approximately \$1.4 billion in funding, of which approximately \$885 million is for construction. To provide visibility and accountability for this significant CIP effort, staff began providing formal semiannual status reports to T&E, TPAC, and Council in spring 2013.

The first semiannual status report was published in April 2013 and focused on progress and activities from July 2012 through December 2012. This report is the fifteenth in the report series and highlights key program and project accomplishments from July 2019 through December 2019. This report also compliments monthly CIP status reports, which staff began issuing in April 2014 to provide more frequent and time-relevant updates. Through December 2019, 69 monthly reports had been issued. Copies of the monthly reports are available at <https://www.sanjoseca.gov/ciparchive>

ANALYSIS

Significant progress was made in key program areas from July 2019 through December 2019.

A. Biosolids Disposition Market Assessment and Procurement Strategy

In September, staff presented an update on biosolids market assessment and disposition options to TPAC, as well as an informational memorandum to Council. Throughout the first half of fiscal year 2019-2020, the team continued to develop the procurement strategy and implementation plan, holding workshops in August and October respectively. These workshops included the review of detailed cost and schedule implications for various disposition options. Over the next few months, the team will continue to develop and finalize the implementation plan.

B. Recruitments

During the first half of fiscal year 2019-2020, staff successfully filled eight vacant positions including the CIP deputy director, a principal engineer, a construction manager, a civil engineer, two sanitary engineers, an associate engineering tech, and an office specialist. Recruitment for project management and construction management positions to support project delivery will continue to be a priority during the second half of fiscal year 2019-2020.

On the project delivery front, there were 19 active projects at various stages of the project delivery model.

A. Feasibility/Development Highlights

Five projects were in the feasibility/development phase during the first half of fiscal year 2019-2020. Key activities completed during this period include the following:

- **Final Effluent Pump Station and Stormwater Channel Improvements:** The US Army Corp of Engineers (USACE) is currently undertaking a shoreline levee project (Shoreline Levee) in South San Francisco Bay (Bay) to protect the region from flooding due to future sea level rise. The Shoreline Levee will include a closure structure that will prevent gravity flow of the RWF's final effluent to the Bay. In July, the City initiated a project that would construct a new pump station to hydraulically push the RWF's final effluent through or over the new closure structure. During this period, City staff coordinated extensively with USACE to

ensure that the RWF's discharge requirements were accounted for in the levee design. As part of the scope development, staff began evaluating alternatives to a pump station for unimpeded final effluent discharge to the Bay. Options being analyzed include gravity flow (through existing outfall channel or through new pipelines) and offline storage in wetlands. The analysis is expected to be completed by April 2020.

- **Storm Drain System Improvements:** During this period, the design consultant conducted additional flood risk analysis to establish the design criteria and develop alternatives for improving the storm drain system to protect RWF critical infrastructure during major storm events.
- **Yard Piping Improvements – Phase 1:** In summer 2019, the design consultant completed more pipe condition assessments and completed the project alternatives analysis. Based on the assessments and analysis, staff reevaluated the project delivery strategy and recommended changing from a complicated progressive design- build approach to a simpler, phased design-bid-build approach. The revised approach will reduce contract and negotiation uncertainties, allow for a more competitive bidding process, and allow pipe rehabilitation work to start sooner. Design of the first phase is expected to be completed by fall 2020 and construction is anticipated to start in early 2021. Additional condition assessments will be performed in summer 2020.

B. Design Highlights

Seven projects were in the design phase during the first half of fiscal year 2019-2020. Key activities completed during this period include the following:

- **Advanced Facility Control & Meter Replacement – Phase 2:** In August, staff completed the prequalification process and determined that three contractors were qualified to bid on the construction contract. In November, the design consultant completed the final design. The project is expected to advertise in January 2020, with the construction contract award anticipated in June.
- **Digested Sludge Dewatering Facility:** In September, Council approved award of the design-build contract to Walsh Construction. In October, the project team and design-builder held a kickoff partnering session. During this period, the design-builder also conducted several workshops to analyze dewatering options and to plan subsurface utilities/hazardous materials investigations. In addition, the City collected sludge samples for a dewaterability analysis to help establish performance standards for the new mechanical dewatering facility. The City also completed an addendum to the Plant Master Plan environmental impact report (EIR).
- **Filter Rehabilitation:** In September, the City prequalified three contractors to bid on the construction contract, which is anticipated to advertise in March. During this period, the design consultant completed the 90 percent design documents.
- **Fire Life Safety Upgrades:** The design consultant completed the 30 percent design documents and the project team assembled the bid documents. Bid advertisement is anticipated in January.

- **Headworks:** In July, the design-builder completed subsurface investigations of the project site. The project team and design builder held workshops focusing on value engineering, hydraulics, and project risks. The project team also continued to negotiate the definitive contract amendment (DCA) and guaranteed maximum price (GMP) with the design builder. Staff anticipates going to Council for approval of the DCA and GMP in February 2020.

C. Construction Highlights

Seven projects, totaling more than \$269 million, were in construction during the first half of fiscal year 2019-2020 (see Attachment A). One of the seven projects is being delivered using the progressive design-build method, with the remaining six projects being delivered using the design-bid-build approach. Key activities completed during this period include the following:

- **96-inch and 87-inch Settled Sewage Pipes Rehabilitation:** Staff advertised the construction contract in August and received two responsive bids. In November, Council approved the award of the construction contract to Michels Corporation DBA Michels Pipeline Construction. Staff is expected to issue the Notice to Proceed (NTP) in February 2020. Substantial completion is anticipated in early 2021.
- **Advanced Facility Control & Meter Replacement – Phase 1:** The contractor installed flow meters in the Battery B secondary tunnels; installed dissolved oxygen probes and loop-powered flow measurement devices in all clarifiers; and installed signal conduits above the returned activated sludge (RAS) vaults. The contractor began preparations for functional and operational testing, which is anticipated to start in April. Through December 2019, construction was 70 percent complete.
- **Blower Improvements:** The contractor demolished the existing workshop area in Building 40 and constructed a masonry wall for the new variable frequency drive (VFD) electrical room. The contractor installed concrete pads in the new electrical room and began setting the VFDs, valves, and motors. In the Tertiary Blower Building, the contractor completed demolition and electrical work. Through December 2019, construction was approximately 8 percent complete.
- **Cogeneration Facility:** The design-builder completed roof installation on the main generator building and the power and air operations building; and installed the pre-engineered metal building for electrical and mechanical control equipment. The design-builder also installed a fire protection system, gas treatment equipment, cooling towers and chillers, exhaust stacks, and piping across the secondary aeration basin; and pulled medium-voltage (4160V) cables between the newly installed switchgear and several manholes in preparation of connecting to new cogeneration engines to the RWF electrical grid. Through December 2019, construction was approximately 75 percent complete.

- **Digester and Thickener Facilities Upgrade:** During this period, the contractor installed the:
 - roof of the final digester,
 - external insulation and stairway support for all digesters,
 - concrete masonry walls and roofs for the two electrical buildings,
 - windows in new sludge screening building,
 - polymer tanks,
 - covers on the dissolved air flotation treatment (DAFT) tanks,
 - footings and columns for the elevated gas pipe racks, and
 - two new flares, along with associated piping and electrical equipment. Work continued on conduit installation around the digesters and for various equipment pads, interior work on digesters 5-8, the distributed controls system, electrical system, and fire system. The contractor also completed the foundation ring beams for digesters 5-8. In addition, the contractor redirected digester gas from existing pipework in the tunnels for four remote digesters to new gas piping on the elevated pipe racks. Startup planning began for the remote digesters, and DAFT tanks. Through December 2019, construction was approximately 85 percent complete.
- **Nitrification Clarifiers Rehabilitation - Phase 1:** In July, the City received four bids. In October, Council awarded the construction contract to the lowest responsive bidder, C. Overaa & Co. The City issued the NTP to the contractor in November. Substantial completion is anticipated in early 2023.
- **Switchgear M4 Replacement and G3 & G3A Removal:** The City advertised the construction contract for bids in August. Council awarded the construction contract to Blocka Construction, Inc. in December. Staff anticipates issuing the NTP in March. Substantial completion is anticipated in mid-2022.

Staff, contractors, and consultants continued to work safely and there were no reportable incidents to the State's Division of Occupational Safety and Health (Cal/OSHA) during the first half of fiscal year 2019-2020.

Staff expects to achieve the following during the second half of fiscal year 2019-2020:

1. Obtain Council approval of the Headworks DCA and GMP.
2. Obtain Council approval to award construction contracts for Advanced Facility Control and Meter Replacement - Phase 2 project.
3. Advertise and obtain Council approval to award master consultant agreements for construction management services.
4. Issue NTP for 96-Inch and 87-Inch Settled Sewage Pipe Rehabilitation and Switchgear M4 Replacement and G3 & G3A Removal projects
5. Advertise the construction contracts for the Facility-wide Water System Improvements Trenching and Filter Rehabilitation projects.
6. Continue to develop the construction management and testing, startup and commissioning strategies.

7. Host a vendor open house to advertise upcoming design, construction, and professional services contract opportunities.
8. Continue recruitment activities to fill remaining RWF CIP vacancies to the extent possible given the City's response to COVID-19.

EVALUATION AND FOLLOW-UP

No follow-up action is required at this time. Staff will continue to provide regular updates to inform T&E, TPAC, and Council of significant changes or issues (particularly as related to rate impacts) as implementation of the CIP progresses. In addition to semiannual presentations, staff will continue to share monthly progress reports with TPAC.

COORDINATION

This report has been coordinated with the Office of the City Attorney and City Manager's Budget Office.

CEQA

Not a Project, File No. PP17-009, Staff Reports, Assessments, Annual Reports, and Information Memos that involve no approvals of any City action.

/s/

KERRIE ROMANOW
Director, Environmental Services

/s/

MATT CANO
Director, Public Works

For questions, please contact Napp Fukuda, Assistant Director, Environmental Services Department at (408) 973-5353.

Attachment A – Projects in Construction: July 2019 – December 2019

#	Project Name	Contractor	Amount Awarded	Date Awarded	Estimated Beneficial Use
1.	9002 – 96-inch and 87-inch Settled Sewage Pipe Rehabilitation	Michels Pipeline Construction	Base Contract: \$4,796,571 Contingency: \$719,486	11/19/19	Winter 2020
2.	7757 – Advanced Facility Control Meter Replacement - Phase 1	C. Overaa & Co.	Base Contract: \$5,790,000 Contingency: \$1,158,000	5/22/18	Summer 2021
3.	8073 – Blower Improvements	Monterey Mechanical Company	Base Contract: \$29,498,000 Contingency: \$4,425,000	10/30/18	Fall 2022
4.	7418 – Cogeneration Facility	CH2M HILL Engineers, Inc.	Base Contract: \$89,071,932 Contingency: \$2,100,068	4/26/16 ¹	Fall 2020
5.	7382 – Digester and Thickener Facilities Upgrade	Walsh Construction Company II, LLC	Base Contract: \$107,925,000 Contingency: \$53,490,625	5/24/16	Fall 2020
6.	7731 – Nitrification Clarifiers Rehabilitation – Phase 1	C. Overaa & Co.	Base Contract: \$26,184,000 Contingency: \$5,237,000	10/22/19	Fall 2022
7.	7759 – Switchgear M4 Replacement and G3 & G3A Removal	Blocka Construction, Inc.	Base Contract: \$5,519,000 Contingency: \$827,850	12/17/19	Spring 2022

1. On April 26, 2016, Council approved the design-build contract and authorized the City Manager to negotiate and execute the definitive contract amendment setting the guaranteed maximum price (GMP). On May 25, 2018, the City manager approved the amended contract.

City Manager's Contract Approval Summary
For Procurement and Contract Activity between \$100,000 and \$1.3 Million for Goods and \$100,000 and \$320,000 for Services

FEBRUARY 1, 2020 - APRIL 30, 2020

Description of Contract Activity ¹	Fiscal Year	Req#/ RFP#	PO#	Vendor/Consultant	Original Amount	Start Date	End Date	Additional Amount	Total Amount	Comments
1 FRICTION & NON FRICTION PARTS PROVIDED TO RWF	19-20	27891	57314	MOTION INDUSTRIES, INC.	\$225,000	07/01/19	06/30/20	\$10,000	\$235,000	DURING ROUTINE MAINTENANCE, IT WAS FOUND THAT THE ROD ASSEMBLY FOR THE FLOCCULATOR PRIMARY AREA NEEDED CRITICAL REPAIRS.
2 BROKER, ADMINISTRATIVE, AND CLAIMS MANAGEMENT SERVICES TO ESTABLISH AND MAINTAIN AN OCIP	19-20		AC25994	ALLIANT INSURANCE SERVICES, INC.	\$158,000	02/14/20	02/01/21		\$158,000	SERVICE ORDER 06 (MASTER CONSULTANT AGREEMENT TERM 12/14/16-12/13/21, \$900K)
3 OWNER'S ADVISOR SERVICES DURING PRELIMINARY SERVICES STAGE OF THE HEADWORKS IMPROVEMENTS AND NEW HEADWORKS PROJECT	19-20		AC27269	CDM SMITH	\$1,404,765	02/05/20	07/31/20	\$340,141	\$1,744,906	SERVICE ORDER 04 FIRST AMENDMENT (MASTER CONSULTANT AGREEMENT TERM 12/21/15-12/31/22; AMENDED AND RESTATED TERM 6/14/16-12/31/22, \$9.6M)
4 OWNER'S ADVISOR SERVICES DURING THE PRELIMINARY SERVICES STAGE OF THE DIGESTED SLUDGE DEWATERING FACILITY PROJECT	19-20		AC28016	BROWN AND CALDWELL	\$1,619,778	03/02/20	10/31/21		\$1,619,778	SERVICE ORDER 03 (MASTER CONSULTANT AGREEMENT TERM 11/2/16-12/31/23, \$7.7M)
5 ENGINEERINGS SERVICES DURING DESIGN, BID AND AWARD FOR YARD PIPING IMPROVEMENTS PHASE I	19-20		AC29225	BLACK AND VEATCH	\$390,864	03/09/20	04/30/21		\$390,864	SERVICE ORDER 03 (MASTER CONSULTANT AGREEMENT TERM 4/24/18-6/30/26, \$9.75M)
6 GENERAL ENGINEERING SERVICES FOR PROCESS OPTIMIAZATION STUDY TO IDENTIFY AND EVALUATE OPTIONS FOR OPTIMIZING UNIT TREATMENT PROCESSES	19-20		AC27586	BROWN AND CALDWELL	\$839,000	04/07/20	03/31/21		\$839,000	SERVICE ORDER 07 (MASTER CONSULTANT AGREEMENT TERM 5/20/16-6/30/23, \$5M)
7 CONDITION ASSESSMENT, PROJECT DEFINITION REPORT, PROCUREMENT SUPPORT AND ENGINEERING DESIGN SERVICES FOR YARD PIPING AND ROAD IMPROVEMENTS PROJECT	19-20		AC29225	BLACK AND VEATCH	\$2,094,357	04/07/20	11/30/20	\$682,500	\$2,776,857	SERVICE ORDER 01 SECOND AMENDMENT (MASTER CONSULTANT AGREEMENT TERM 4/24/18-6/30/26, \$9.75M)
8 CONSTRUCTION MANAGEMENT AND INSPECTION SERVICES FOR BLOWER IMPROVEMENTS	19-20		AC27747	MNS ENGINEERS	\$2,298,099	04/21/20	03/30/22	\$877,161	\$3,175,260	SERVICE ORDER 03 SECOND AMENDMENT (MASTER CONSULTANT AGREEMENT TERM 6/14/16-6/30/24, \$8M)
9 CONSTRUCTION MANAGEMENT FOR NITRIFICATION CLARIFIER PHASE I	19-20		AC27747	MNS ENGINEERS	\$1,708,000	04/30/20	12/31/22	\$1,251,000	\$2,959,000	SERVICE ORDER 05 FIRST AMENDMENT (MASTER CONSULTANT AGREEMENT TERM 6/14/16-6/30/24, \$8M)
10 CONSTRUCTION MANAGEMENT AND INSPECTION SERVICES FOR ADVANCED FACILITY CONTROL AND METER REPLACEMENT PHASE I	19-20		AC27747	MNS ENGINEERS	\$715,212	04/30/20	06/30/21	\$233,700	\$948,912	SERVICE ORDER 02 SECOND AMENDMENT (MASTER CONSULTANT AGREEMENT TERM 6/14/16-6/30/24, \$8M)