

### Item 3.10 BART SILICON VALLEY PHASE II EXTENSION

Roland Lebrun <[REDACTED]>

Tue 12/7/2021 5:36 AM

To: The Office of Mayor Sam Liccardo <TheOfficeofMayorSamLiccardo@sanjoseca.gov>

Cc: Taber, Toni <toni.taber@sanjoseca.gov>; VTA Board Secretary <board.secretary@vta.org>; BART Board <boardofdirectors@bart.gov>; City Clerk <city.clerk@sanjoseca.gov>

📎 5 attachments (2 MB)

BART Silicon Valley Extension Alternate Tunneling Strategy (Concept C).pdf; 1a457176ca8057874d83ac5d32fab522-740x385-0\_500x0\_500.jpg; Downtown concourse.jpg; Single Bore.jpg; f37144222add3c8baecd721f04d70ca1-740x385-0\_500x0\_500.jpg;

[External Email]

[External Email]

Dear Mayor Liccardo,

Thank you for your memo directing VTA to "*evaluate the most design flexible construction method, such as progressive-design-build for CP4*", (<http://sanjose.legistar.com/gateway.aspx?M=F&ID=0d4e1ba6-9220-4c92-b575-55d83dc8d759.pdf>) but a single-bore tunnel design mandates that the tunnel itself (CP2) should be able to accommodate the tracks and the platform as well as the concourse (inside the tunnel crown) as **this is the only way to facilitate entrances on BOTH sides of the street.**

Please direct staff to review the attached revised tunneling strategy which uses the integrated BART/LRT DISC box to transition from twin bores to a 1.5-mile 56-foot diameter tunnel for the Downtown section (between Diridon and 13th Street) and report back to Council with a recommendation.

Thank You.

Roland Lebrun

CC

VTA Board  
BART Board

This message is from outside the City email system. Do not open links or attachments from untrusted sources.

This message is from outside the City email system. Do not open links or attachments from untrusted sources.

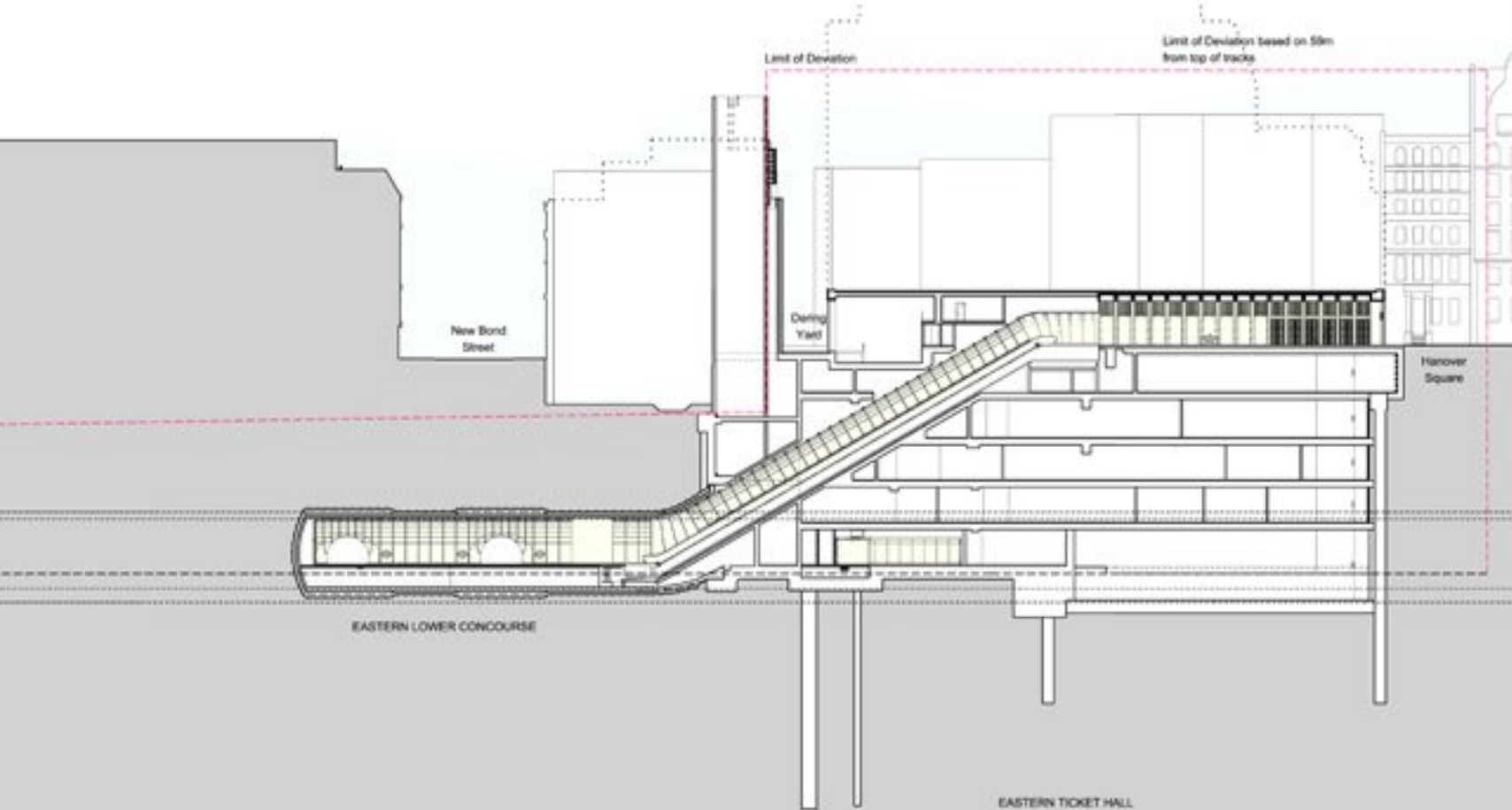

# Center Platform at Stations

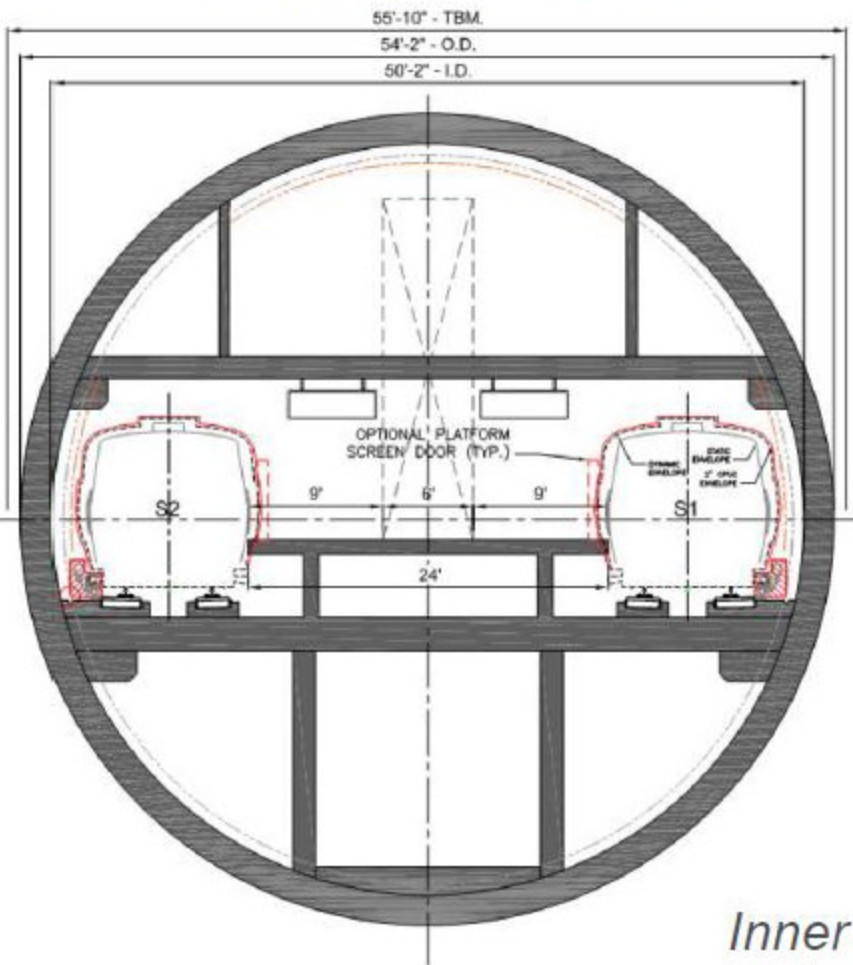



Eisenbahn  
Mehrfachparking I

Eisenbahn  
Mehrfachparking I

Eisenbahn  
Mehrfachparking I

Mehrfachparking I

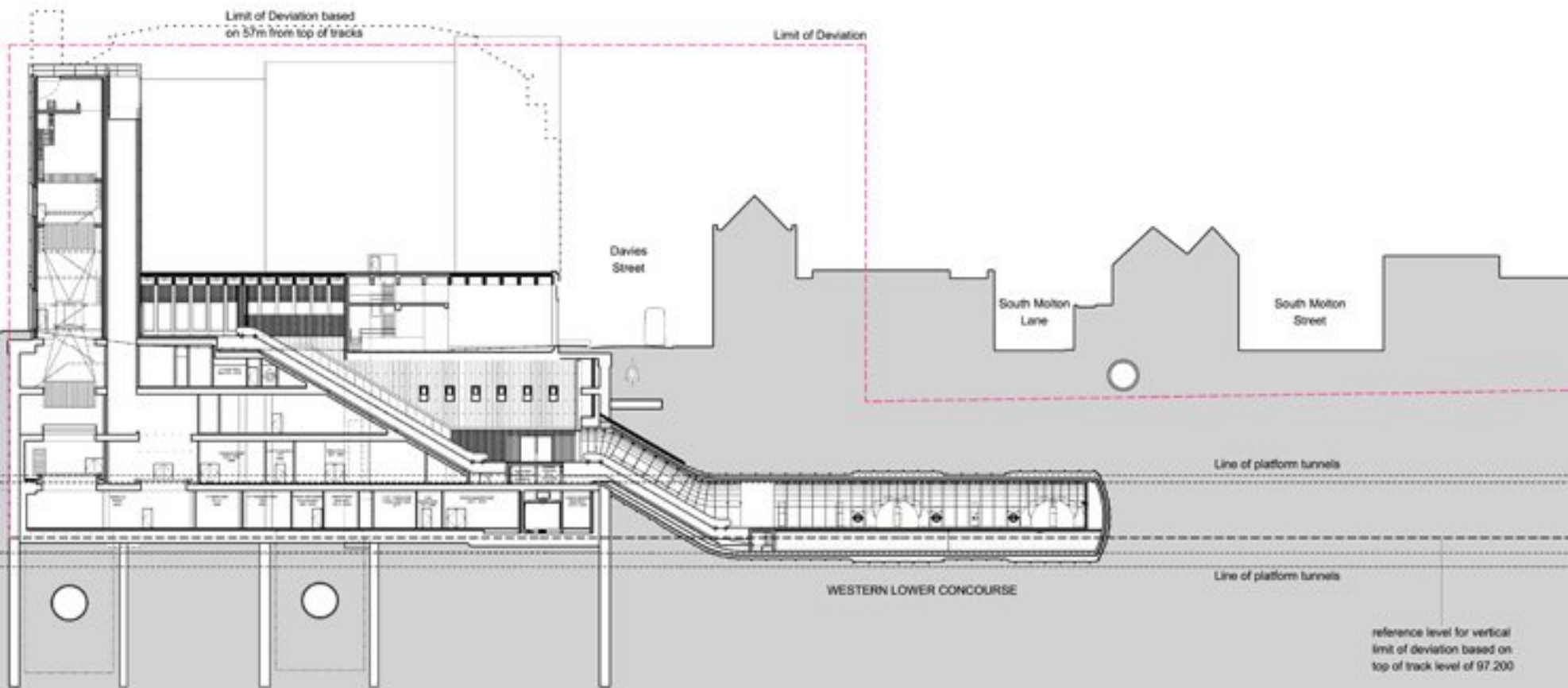

## Executive summary

The objective of this document is to introduce a revised BART Silicon Valley Extension tunneling strategy designed to:

- **Address equity issues**
  - o **Equitable outcomes for Downtown WEST and Downtown EAST**
  - o **Station entrances on BOTH sides of Santa Clara Street (2007 SEIR)**
  - o **No surface impacts between stations (Crossrail 2007)**
- **Increase value capture**
  - o **Eliminate all impediments to Over Site Development (OSD)**
- **Reduce risks**
  - o 3 separate tunnel contracts (Crossrail 2007/Channel Tunnel Rail Link)
  - o Improved fire/life safety (BART Facilities Standards/Arup HS2 2009)
  - o **Reduce potential impacts on single-bore tunnel superstructure integrity**
  - o **Eliminate all large elevator shafts**
- **Reduce costs**
  - o **Eliminate 3.5 miles of single-bore tunneling**
  - o **Eliminate all vent shafts and trenches between stations (Crossrail 2007)**
  - o **Eliminate all ramps and stacked platforms**
  - o Preserve 400 feet of **brand new** Berryessa tail tracks
  - o **Simultaneous (3x faster) tunneling (potentially two years or less)**
- **Phased implementation**
  - o Additional station entrances integrated with adjacent P3 opportunities

<b>Current strategy</b>	<b>Revised strategy</b>
6-Mile Extension:	6-Mile Extension:
- 1.1 mile single-bore stacked	- <b>1.5 mile single-bore side-by-side</b>
- 3.2 mile single-bore side-by-side	- <b>3.5 mile TWIN-bore side-by-side</b>
- 0.7 mile single-bore transition zone	- <b>NO transition zones</b>
- 1 mile at-grade	- 1 mile at-grade
4 Stations:	<b>5 Stations:</b>
- 3 underground	- <b>4 underground</b>
- 1 at-grade	- 1 at-grade
Newhall Yard Maintenance Facility:	Newhall Yard Maintenance Facility:
- Critical for BART operations	- Critical for BART operations

## Background to Revised Tunneling Strategy (Concept #3)

April 17<sup>th</sup> 2020 Board of Directors Special Meeting:

VTA staff and consultants introduced an alternative known as the “Optimized Single Bore Stacked Concept #2” which included a “**Twin bore configuration east of 13<sup>th</sup> Street with cut & cover center platform station at 28<sup>th</sup> Street/Little Portugal**”

<http://santaclaravta.igmp2.com/Citizens/FileOpen.aspx?Type=4&ID=9516&MeetingID=3331>

(slide 9)

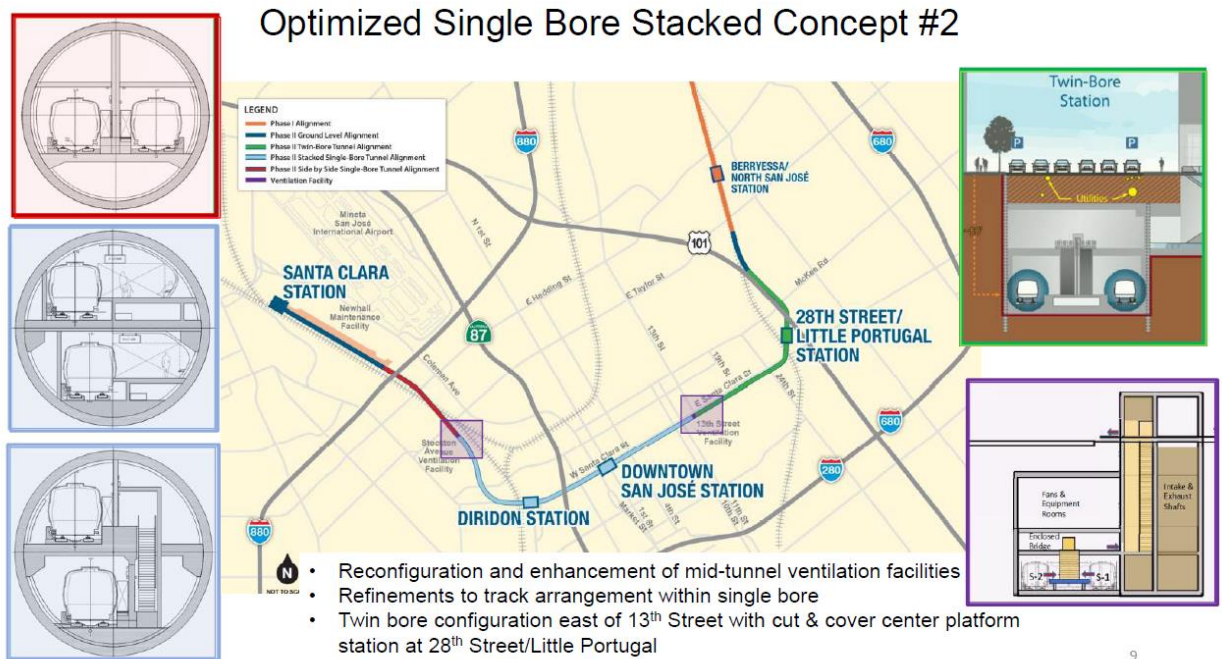

Concept #3 builds on Concept #2 by:

- Additionally transitioning to **twin bores between Diridon and the Newhall Portal**
- **Increasing the bore of the Diridon to 13<sup>th</sup> Street section from 48 feet to 56 feet**
- **Extending the side-by-side tracks section to the entire 5 miles of tunneling**

### Tunnel Section 1: Newhall to the Diridon Integrated station box (1.5 miles)

- Twin 22-foot bores with cross-passages every 300 feet (BART Facilities Standards)
- **Elimination of Stockton Avenue emergency platform trench**
- **Elimination of Stockton Avenue ventilation shaft (Mayor Boris Johnson 2009)**
- Evacuation/rescue through adjacent (“non-incident”) tunnel (Arup HS2 2009)

## Diridon Integrated Station Box

Transition from twin 22-foot bores to a 56-foot single bore “For twin bored tunnels the spacing of the two bores is assumed to be 0.5 times the TBM or starter chamber diameter to the inside face of the portal cutting, with one tunnel diameter between the bores. **This may be reduced if required, particularly for TBM reception.** (Arup HS2 2009)

White Street (western) headwall



S. Montgomery (eastern) headwall



## Station Configuration Concept - Diridon

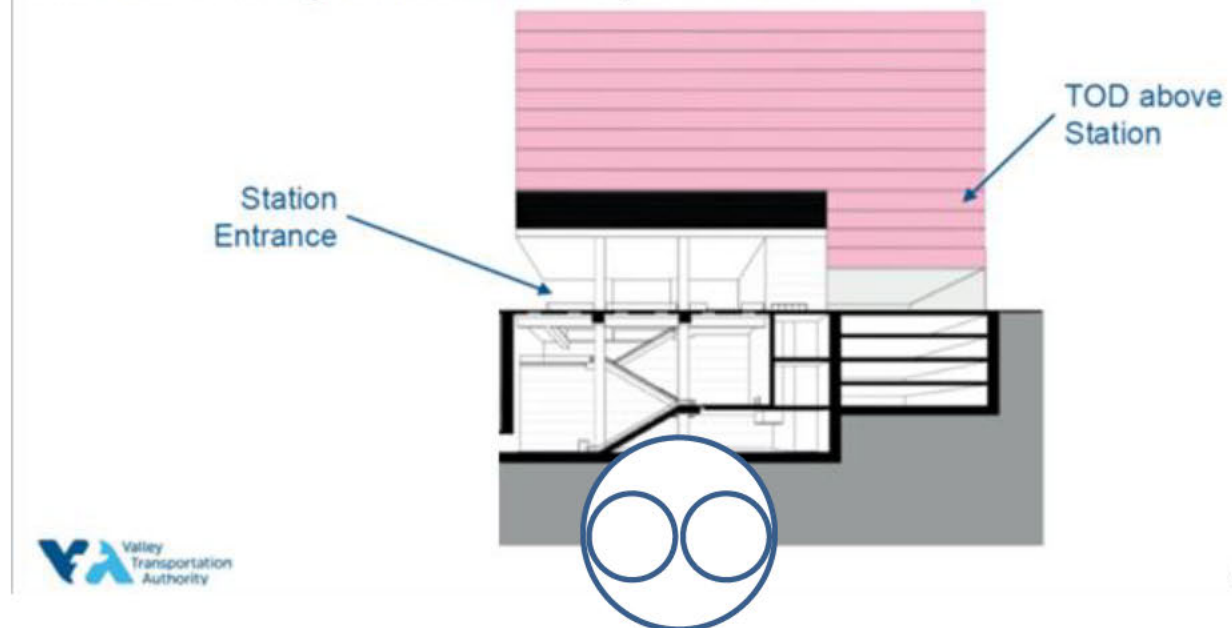

- Seamless integration with Caltrain, ACE, Capitol Corridor, Amtrak and HSR (Level +1)
- Seamless integration with VTA light rail (Level -2)
- Seamless integration with the Airport Connector (Level -4)
- Twin 30-foot outboard platforms eliminate BART platform overcrowding during peak and after games or special events



## Tunnel Section 2: Diridon to 13<sup>th</sup> Street (1.5 miles)

This section includes two identical stations: Downtown and the new 13<sup>th</sup> Street station

### Single-Bore: Center Platform Configuration

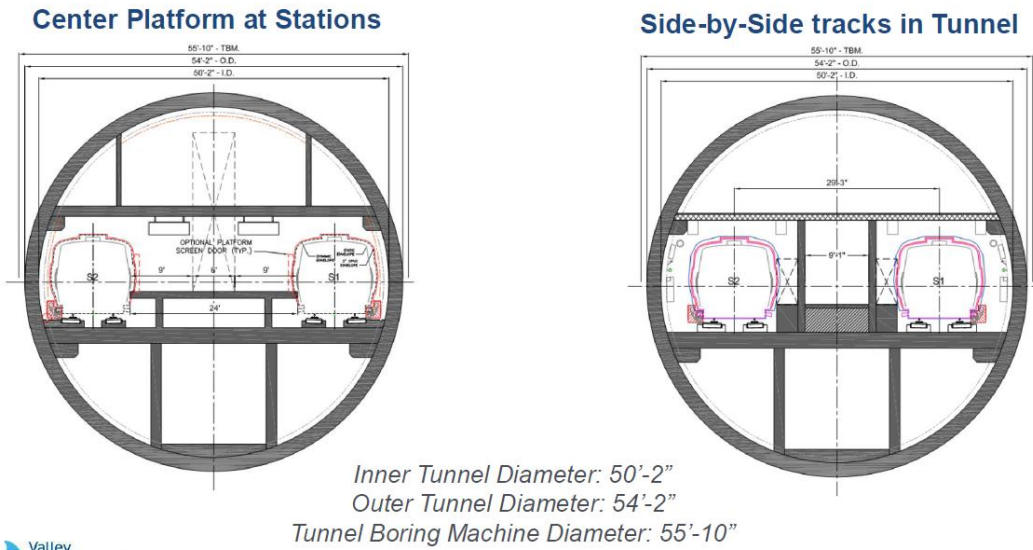

6

### Single-Bore: Center Platform Configuration

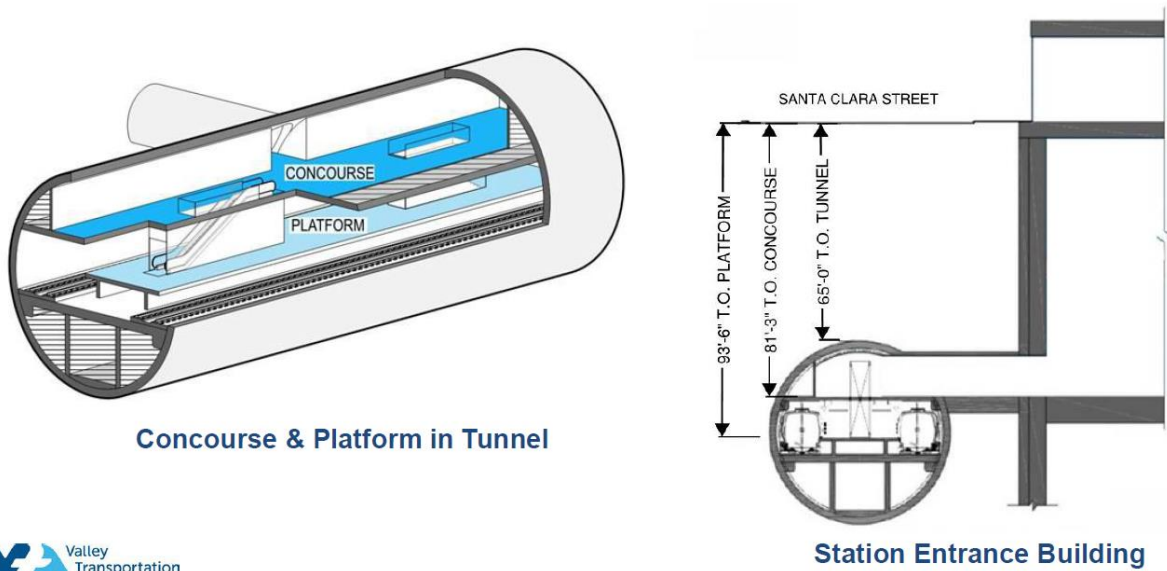

7

## Elimination of all vent structures between stations

### Station Ventilation Facilities

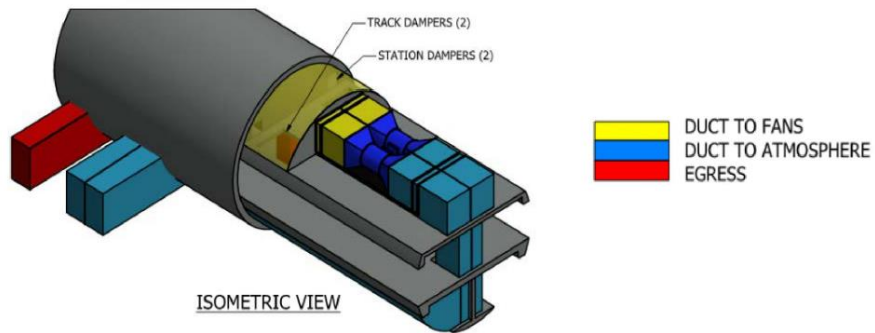

Larger diameter tunnel provides opportunities to locate ventilation components in tunnel



10

## Eliminate potential impacts on single-bore tunnel superstructure integrity

View of the Downtown concourse showing connections to entrances south (left) and north (right) of Santa Clara Street. **Please note that the concourse** can be located anywhere within the tunnel crown and **can exceed the length of the platforms by hundreds of feet if necessary** (example: between Market and 4<sup>th</sup> Street)



4<sup>th</sup> Street City Hall/SJSU entrance

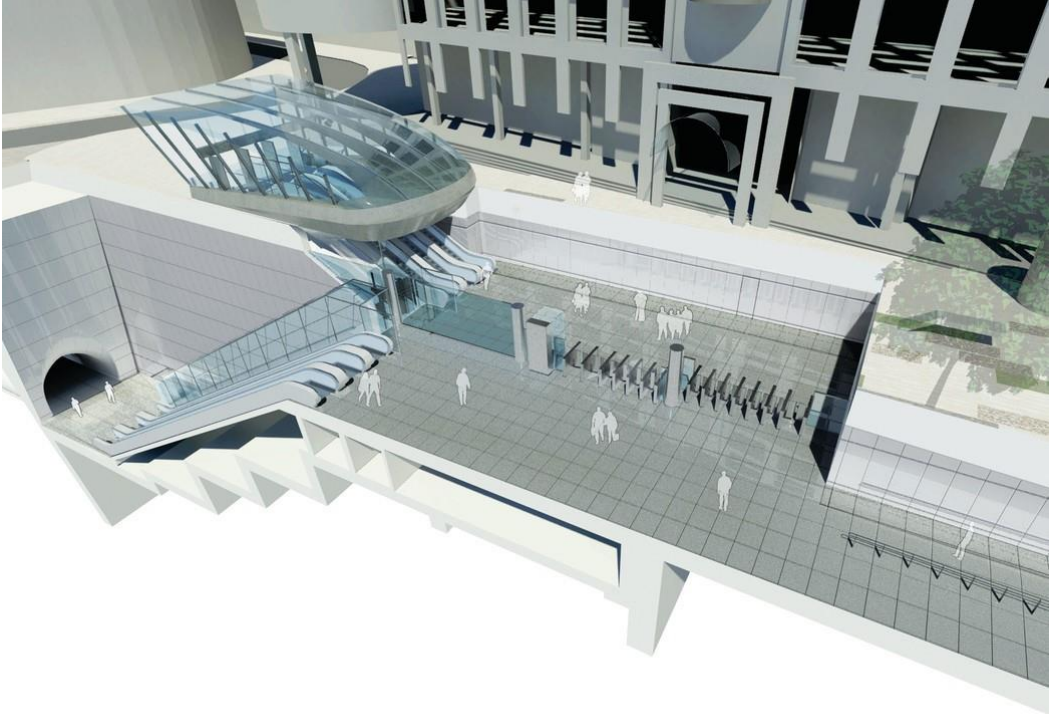

Fountain Alley entrance



## 13<sup>th</sup> Street Station

The 13<sup>th</sup> Street station will be identical to the Downtown station. The only impact on East Santa Clara will be a temporary shaft designed to enable the transition between the 56-foot TBM and the twin 22-foot TBMs when they arrive from the 28<sup>th</sup> Street station. The location of the shaft will delimit the eastern end of the 13<sup>th</sup> Street station and will be integrated into the station's eastern headhouse after tunneling completes.

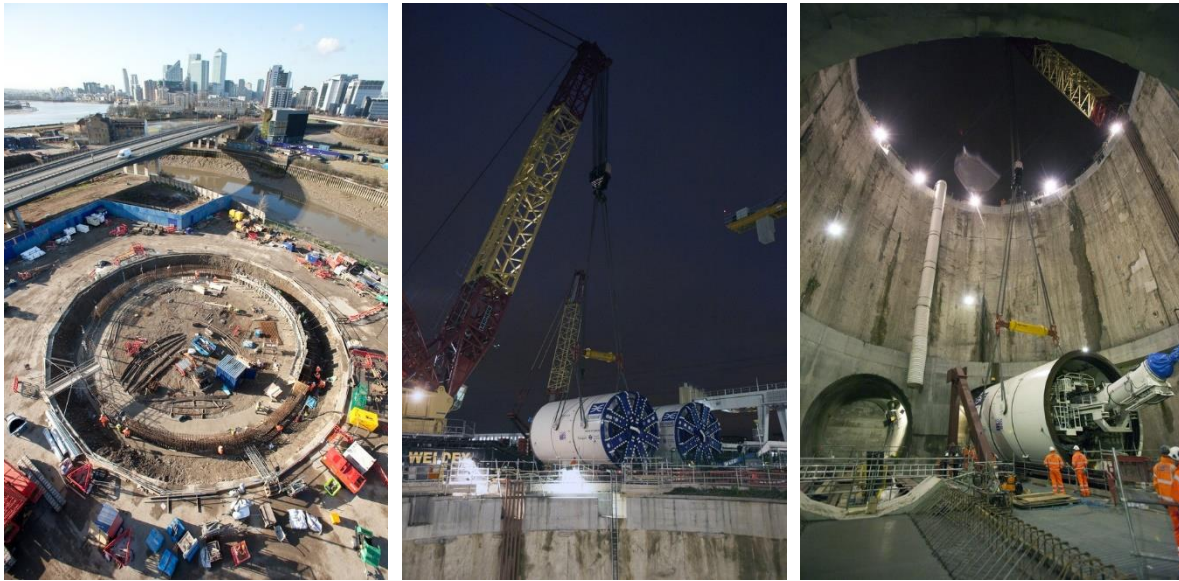

Additional 13<sup>th</sup> Street station entrances will be integrated into adjacent P3 opportunities as and when they materialize



## Tunnel Section 3: 13<sup>th</sup> Street shaft to Las Plumas portal (2 miles)

- Twin 22-foot bores with cross-passages every 300 feet (BART Facilities Standards)
- Evacuation/rescue through adjacent (“non-incident”) tunnel (Arup 2009)
- Smaller tunnel diameters
  - o **Lower risks tunneling under Coyote Creek and Highway 101**
  - o **Reduce 28<sup>th</sup> Street station depth by approximately 30 feet**
  - o Preserve 400 feet of **brand new** Berryessa tail tracks

Station Artwork Location

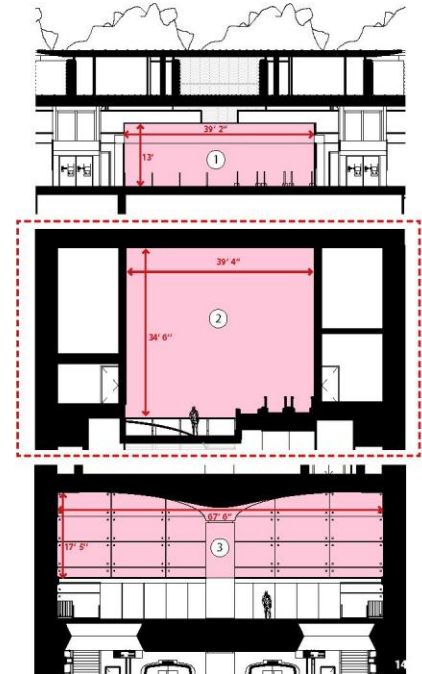
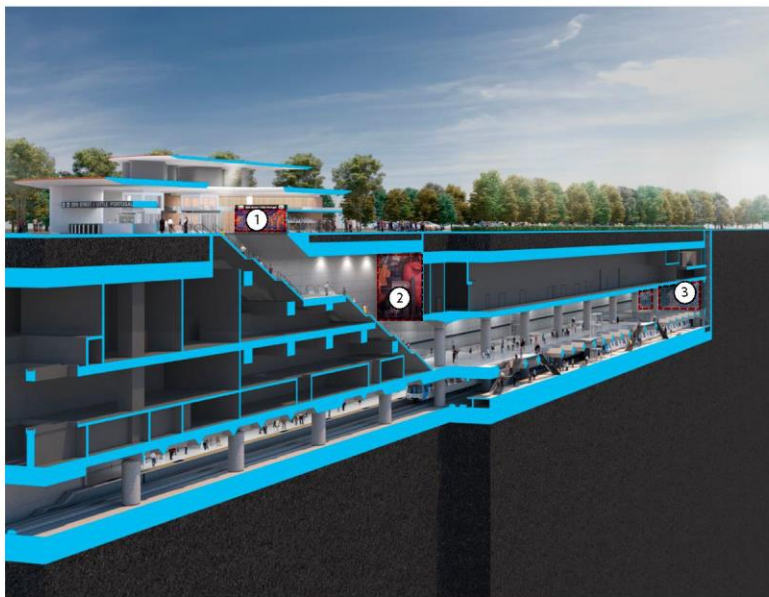

## References

- Channel Tunnel Rail Link (CTRL) Risk Transfer and Innovation in Project Delivery  
<https://research.gsd.harvard.edu/zofnass/files/2013/05/CTRL.pdf>
- **Mayor Boris Johnson Press Release announcing the elimination of 8 Crossrail shafts**  
<https://www.crossrail.co.uk/news/articles/impact-crossrail-construction-to-be-lessened-as-eight-shafts-are-removed-from-tunnel-design>  
<https://www.constructionnews.co.uk/civils/contracts-civils/crossrail-shafts-removed-from-central-tunnel-03-04-2009/>
- Appendix 1 Arup single and twin-bore tunnel safety studies (HS2 2009)
- Appendix 2 Crossrail 2007 Construction Methodology (Section 4 Environment Impact)

**Re: Item 3.10 BART SILICON VALLEY PHASE II EXTENSION**

Roland Lebrun [REDACTED]

Tue 12/7/2021 4:59 PM

**To:** The Office of Mayor Sam Liccardo <TheOfficeofMayorSamLiccardo@sanjoseca.gov>; Mahan, Matt <Matt.Mahan@sanjoseca.gov>

**Cc:** Taber, Toni <toni.taber@sanjoseca.gov>; VTA Board Secretary <board.secretary@vta.org>; BART Board <boardofdirectors@bart.gov>; City Clerk <city.clerk@sanjoseca.gov>

 5 attachments (2 MB)

BART Silicon Valley Extension Alternate Tunneling Strategy (Concept C).pdf; 1a457176ca8057874d83ac5d32fab522-740x385-0\_500x0\_500.jpg; Downtown concourse.jpg; Single Bore.jpg; f37144222add3c8baecd721f04d70ca1-740x385-0\_500x0\_500.jpg;

[External Email]

[External Email]

VTA's answer to Councilmember Mahan's question about opportunities for future additional stops as the Downtown core expands is **ABSOLUTELY FALSE**.

As can be seen in the 56-foot single-bore diagram above, the concourse and the centerboard platform could be extended **anywhere between Diridon and 13th Street** with entrances **anywhere there is an opportunity in the vicinity of the platform**.

---

**From:** Roland Lebrun

**Sent:** Tuesday, December 7, 2021 5:35 AM

**To:** mayoremail@sanjoseca.gov <mayoremail@sanjoseca.gov>

**Cc:** Taber, Toni <toni.taber@sanjoseca.gov>; VTA Board Secretary <board.secretary@vta.org>; BART Board <boardofdirectors@bart.gov>; City Clerk <city.clerk@sanjoseca.gov>

**Subject:** Item 3.10 BART SILICON VALLEY PHASE II EXTENSION

Dear Mayor Liccardo,

Thank you for your memo directing VTA to "*evaluate the most design flexible construction method, such as progressive-design-build for CP4*", (<http://sanjose.legistar.com/gateway.aspx?M=F&ID=0d4e1ba6-9220-4c92-b575-55d83dc8d759.pdf>) but a single-bore tunnel design mandates that the tunnel itself (CP2) should be able to accommodate the tracks and the platform as well as the concourse (inside the tunnel crown) as **this is the only way to facilitate entrances on BOTH sides of the street**.

Please direct staff to review the attached revised tunneling strategy which uses the integrated BART/LRT DISC box to transition from twin bores to a 1.5-mile 56-foot diameter tunnel for the Downtown section (between Diridon and 13th Street) and report back to Council with a recommendation.

Thank You.

Roland Lebrun

CC

VTA Board  
BART Board

This message is from outside the City email system. Do not open links or attachments from untrusted sources.

This message is from outside the City email system. Do not open links or attachments from untrusted sources.