

Roland Lebrun
CCSS@MSN.COM

September 19th 2017 City Council Meeting
Item # 6.1 BART Phase II Priorities and Preferred Alternatives

Dear Mayor Liccardo and Members of the City Council,

Thank you for directing staff to encourage VTA and BART to adopt construction techniques designed to mitigate impacts on Downtown residents and businesses.

While I appreciate the simplicity of the single bore methodology, I believe it is the wrong solution based on the following facts:

- **Unsuitability for passenger transit.** Single bore tunnels are used throughout the World for vehicular traffic which does not require crossovers or station platforms. See attached 4/23 letter to the BART Silicon Valley Ad hoc committee highlighting multiple safety issues with the Barcelona L9 crossover design.
- **Excessive tunnel depths mandated by large tunnel diameters,** a point well understood by Elon Musk's Boring Company currently boring 15-foot diameter tunnels 40 feet below the surface.
- **Conflicts with future north/south tunnels @ Diridon (High Speed Rail) and Downtown (future light rail subway tunnels).**
- **Multimodal capacity issues.** As an example, Barcelona's L9 single bore station design could not possibly interface with a large railway station such as Barcelona Sants which connects to conventional subway lines (L3 & L5).
- **No opportunity for development above station entrances (see attached Bond Street pictures)**

Please consider a twin-bore station design similar to London's Bond Street before making a decision that will be your legacy for the next 6-8 generations.

Thank you.

Roland Lebrun.

Attachments:

Single bore crossover safety issue
SVBX Phase II Meeting
Downtown SEIR scoping comments
Bond street pictures

Roland Lebrun
ccss@msn.com
April 23 2017

Dear Mayor Liccardo and Members of the BART Silicon Valley Ad hoc committee,

The intent of this letter is to substantiate and elaborate on the concerns I raised about safety issues related to the single-bore tunnel design proposed by the VTA consultants, specifically a couple of apparent fatal flaws in the downtown crossover design as well as potential difficulties evacuating underground stations in a timely manner.

The following text in *italic* is an extract of

<http://webarchive.nationalarchives.gov.uk/20110131042819/http://www.dft.gov.uk/pgr/rail/pi/highspeedrail/hs2ltd/routeengineering/pdf/appendixatok.pdf> (page A11 Tunnel Configuration).

Twin Bore Tunnels

In the twin bore configuration, the benefit is that cross-passages linking the tunnel can be used by passengers to evacuate from incident to the non-incident tunnel (bore). The cross-passages can be designed as protected routes which are fire separated from each or the bores by fire resisting doors at each side of the cross-passage. The cross-passages may also be pressurized to prevent smoke entering the cross-passages area as passengers are escaping. Once within the non-incident bore, passengers are considered to be in a place of relative safety from where they can be rescued or continue self-evacuation to reach a vertical evacuation/intervention shaft or the tunnel portal.

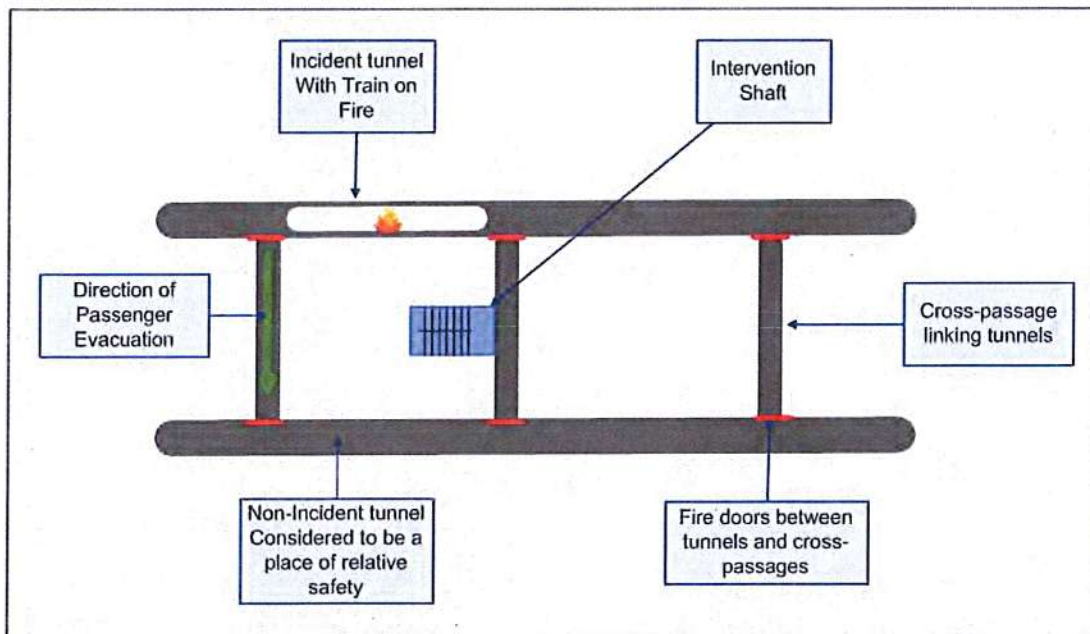

Twin Bore Configuration - Plan View

Single Bore Tunnels

In a single bore configuration, typically the bore will be subdivided by a central wall and a single door will separate the incident and non-incident tracks. To adopt a strategy where passengers evacuate from the incident side to the non-incident side of the tunnel (as outlined for the twin bore configuration above) it will be necessary to prevent the movement of the products combustion, smoke and heat, between the two tracks whilst passengers are evacuating.

Page A12 Ove Arup & Partners Ltd 15 December 2009

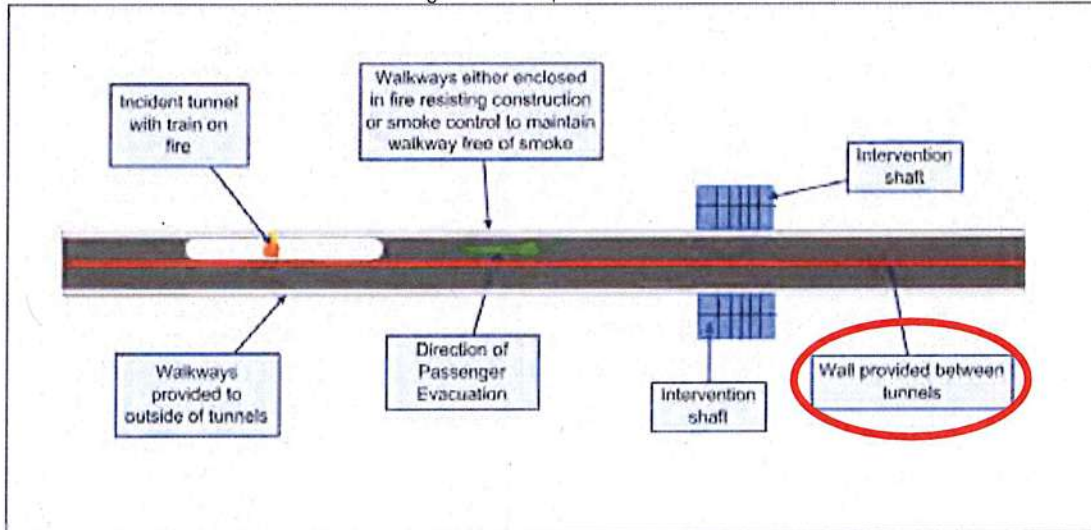

This criteria is met by the most of the designs presented to the Committee on 3/13/17.



Tunnel Typical Sections

✓ Side-By-Side Configuration

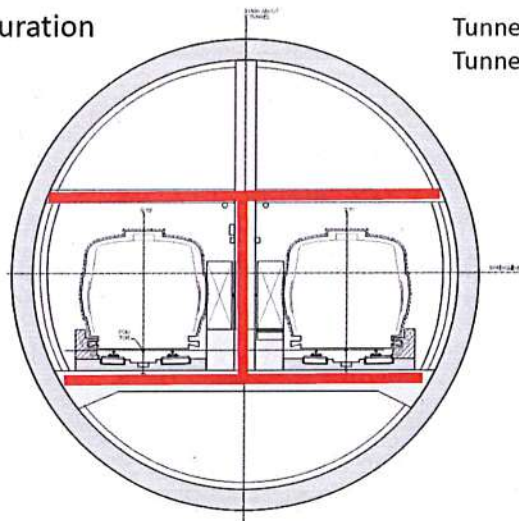

Tunnel Inner Diameter: 41 ft.
Tunnel Outer Diameter: 45 ft.





Tunnel Typical Sections



Stacked Configuration
approaching/ exiting
Stations

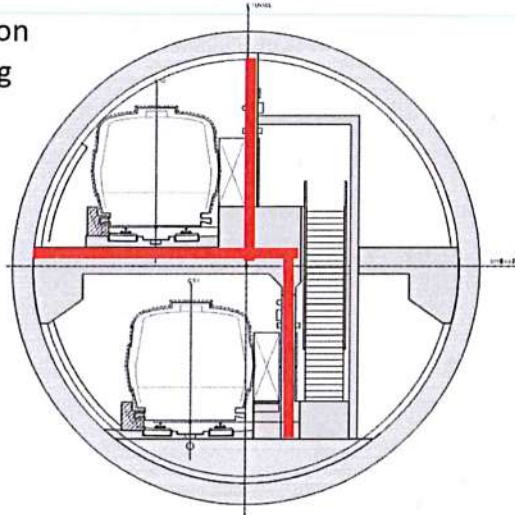

Solutions that move you 5



Tunnel Typical Sections



Stacked Configuration at
Stations

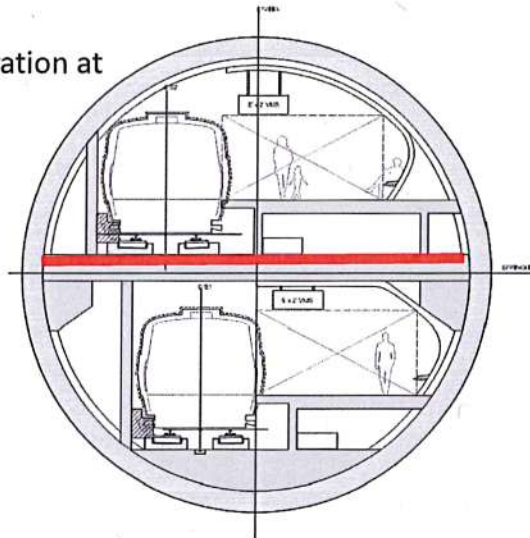

Solutions that move you 6

Please note that Platform Screen Doors (PSDs) are designed to stop smoke from entering the station platforms but are missing from the above diagram.



Tunnel Typical Sections

❌ Crossover configuration ❌

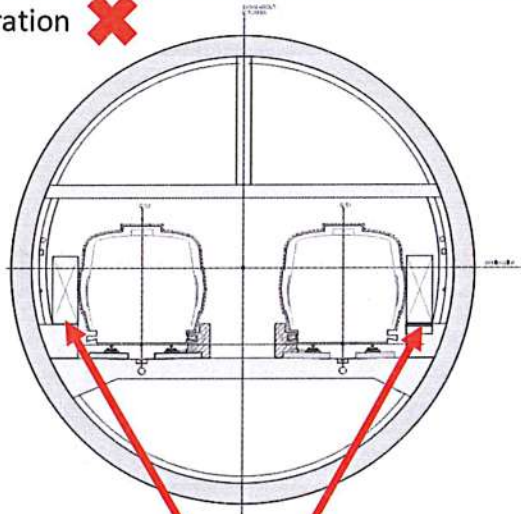

Solutions that move you

7

Non-existent doors/exits



The next fatal flaw is with the fire doors on opposite ends of the crossovers which are designed to prevent smoke/fire from entering the non-incident tunnel. These doors cannot possibly be closed if there is a disabled train in the passage at the time the ventilation system detects smoke in a tunnel, making it impossible to increase the pressure in the non-incident tunnel to turn it into a place of relative safety and/or an escape route.



Barcelona L9 crossover video (40 seconds)

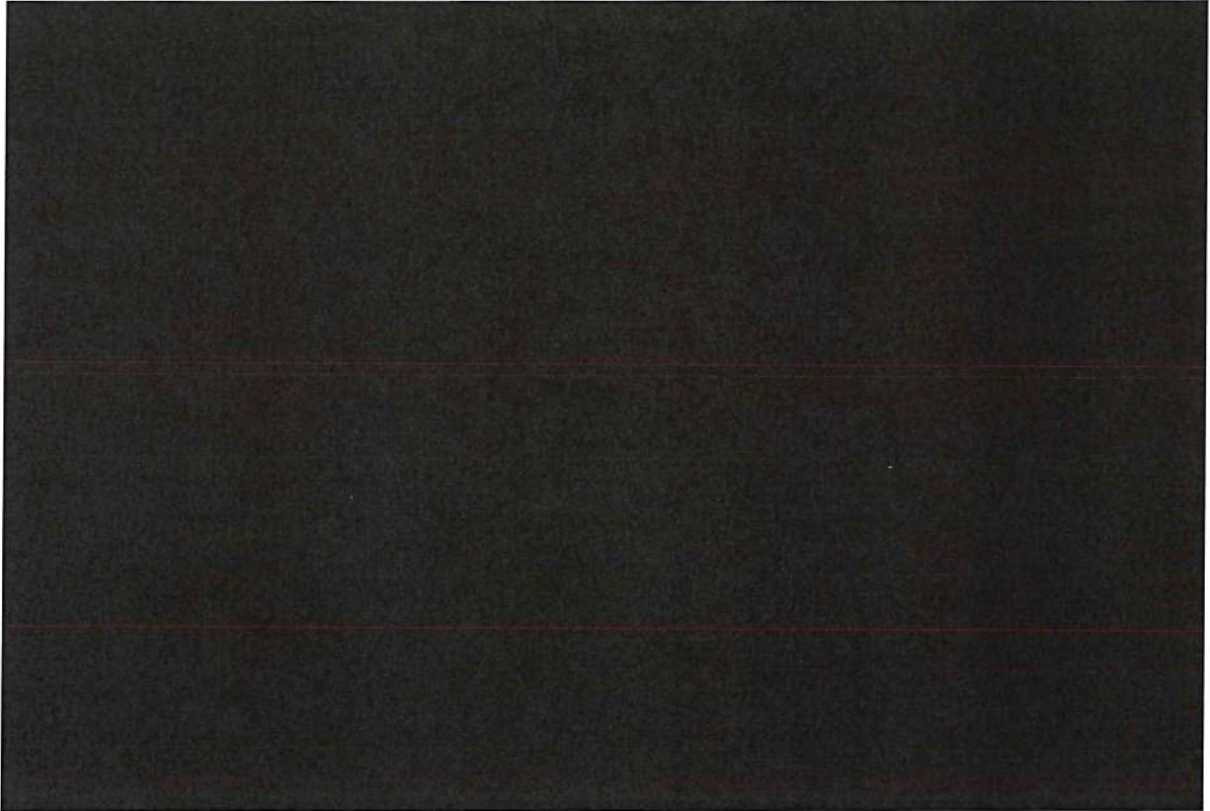

Both flaws are resolved by the Crossrail twin bore crossover design which eliminates the need for fire doors across the tracks and provides cross-passages between the crossover tunnel and the adjacent running tunnel bores.

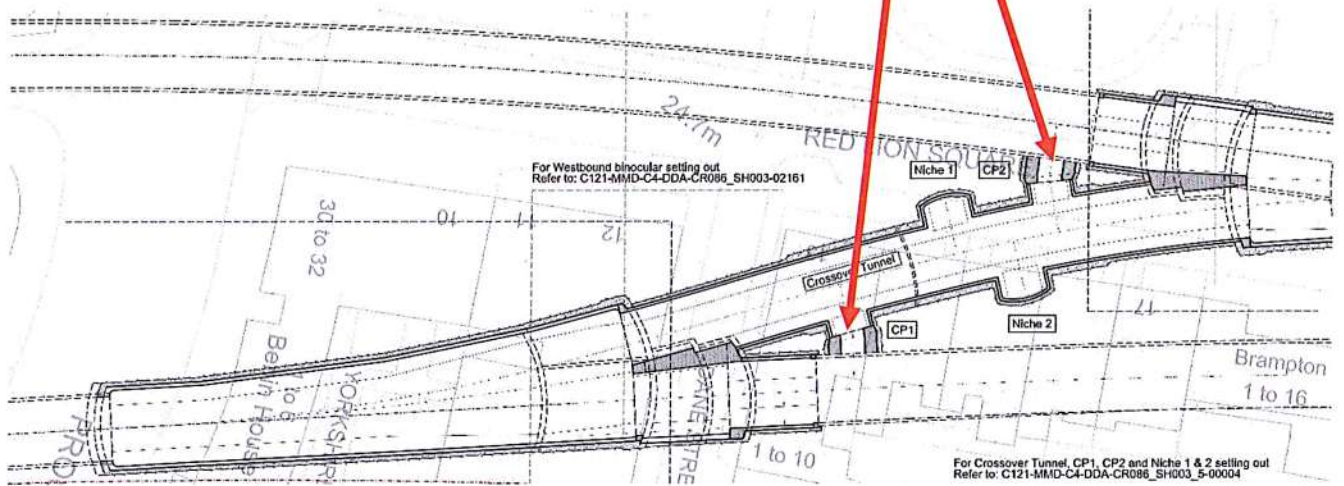

Station design issues

Point of Safety

FORCED EXHAUST AIR VENTILATION PROVIDES

- TENABLE ENVIRONMENT IN PATH OF EGRESS VIA INDUCED MAKE UP FRESH AIR FLOW
- LIMITS THE SPREAD OF FIRE HAZARDS WITHIN PLATFORM AND STATION AREAS

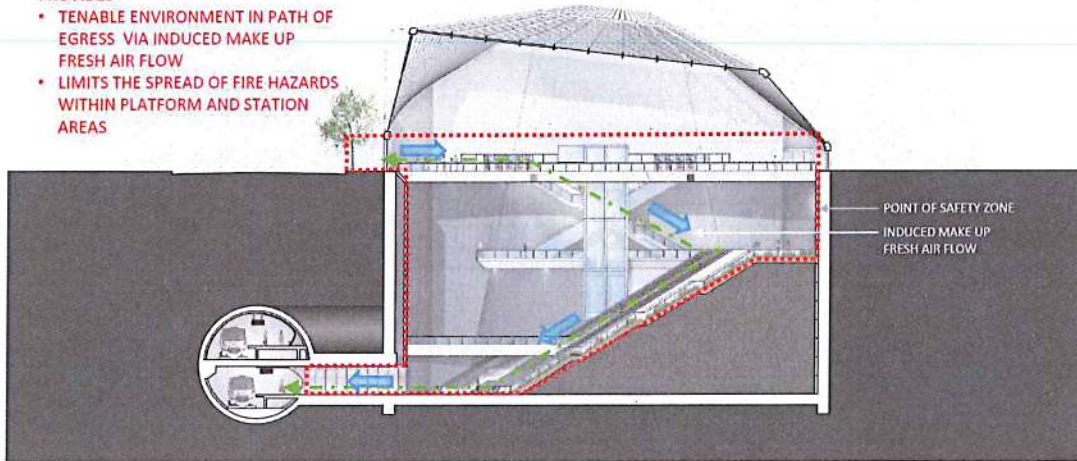

Solutions that move you 18

Once again, Crossrail station design is superior in an emergency because the incident platform (the platform connected to the incident tunnel) is connected via multiple cross-passages to the non-incident platform and/or the central circulation tunnel. Each platform and the central circulation tunnel are in turn connected to the station ticket halls located at the opposite ends of the platforms.

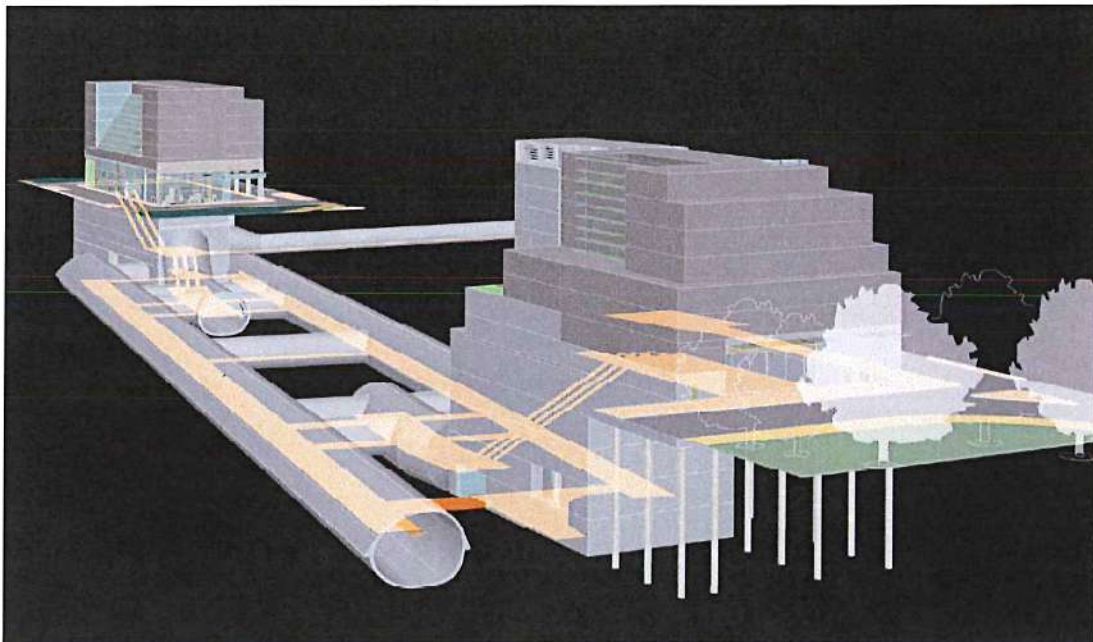

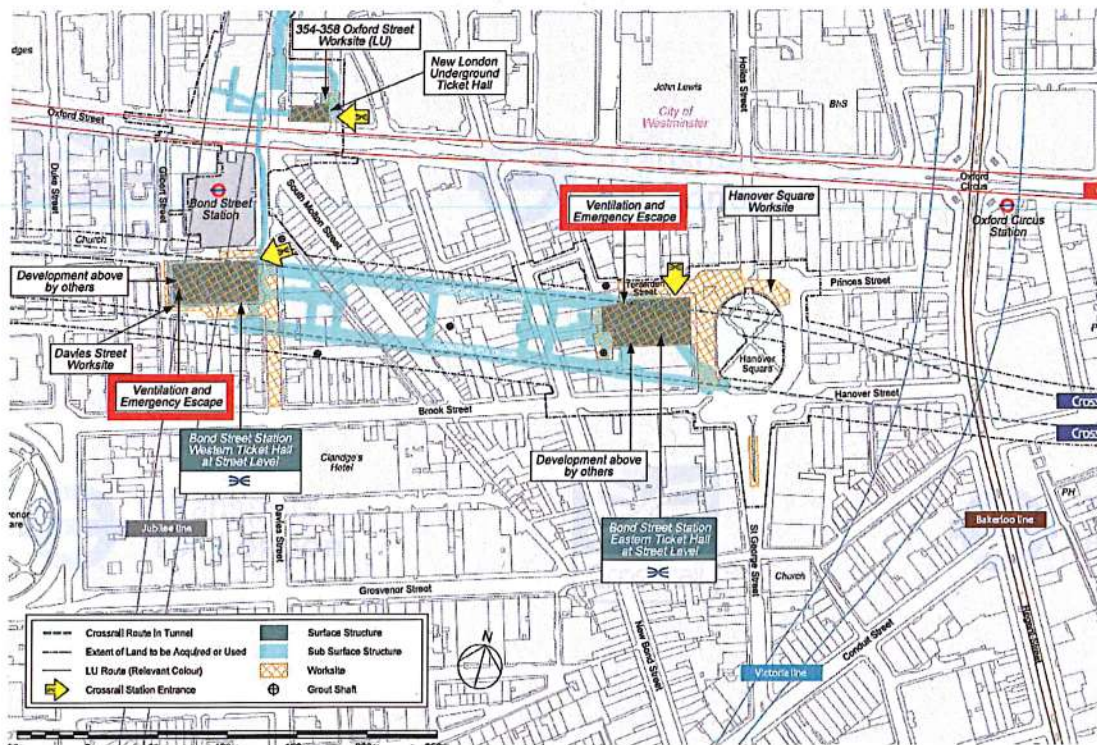

This design eliminates the need for passengers to walk up to 300 feet along a smoke-filled platform to reach an emergency exit

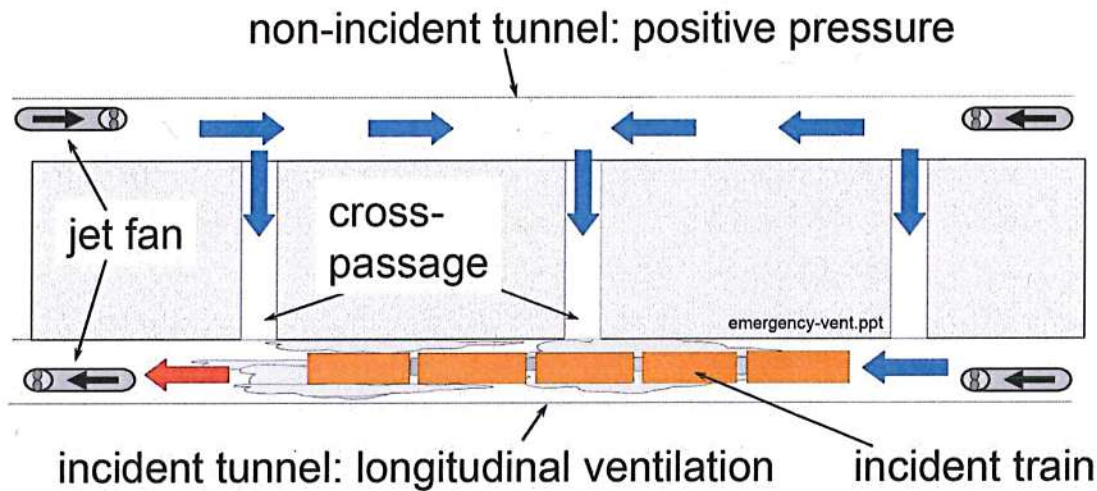

In closing, I hope that you will be able to verify the existence (or lack thereof) of the Barcelona L9 single bore crossover cross-passages and emergency exits during your visit to Barcelona and will do likewise during your Crossrail visit in London.

Sincerely,
Roland Lebrun

Roland Lebrun
ccss@msn.com
BART Silicon Valley Phase II
Nov 19th 2014 meeting
Topics of conversation

Dear Ms. Gonot,

Thank you for allowing me to meet and share initial thoughts on the SVBX Phase II alignment, context-sensitive station design alternatives and, if time allows, to get a better sense of costs (past, present and future), including 150-year tunnel diameter decisions.

1) Potential 23rd Street alignment alternative.

To the best of my knowledge, the 35% design plans for the only alignment approved by the VTA Board south of Las Plumas Avenue are located in appendix C of Volume II of the 2010 Final EIS: <http://www.vta.org/bart/finaeis2010>.

I would like to use this environmentally cleared alignment as the basis for our conversation unless the alignment has changed in which case I would like to review the new alignment and learn more about how a 23rd street station could be constructed “at a later date” without relocating all in-tunnel utilities prior to removing the tunnel lining, the tracks and the slab: <http://www.youtube.com/watch?v=wpEo7Qmot1I>

2) Alum Rock station @ 28th Street

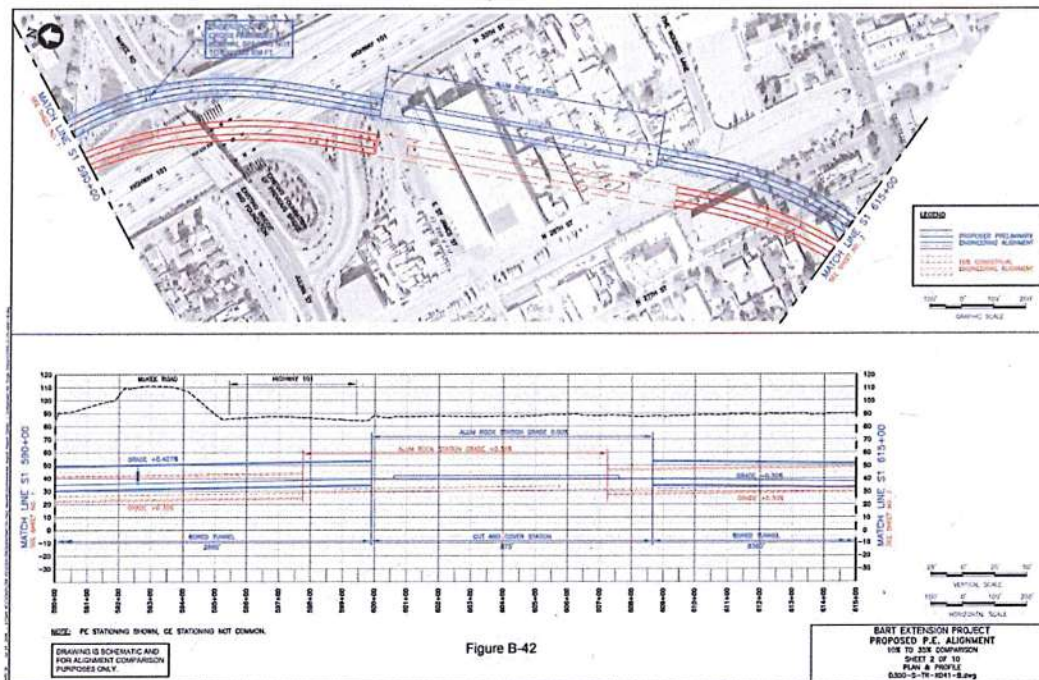
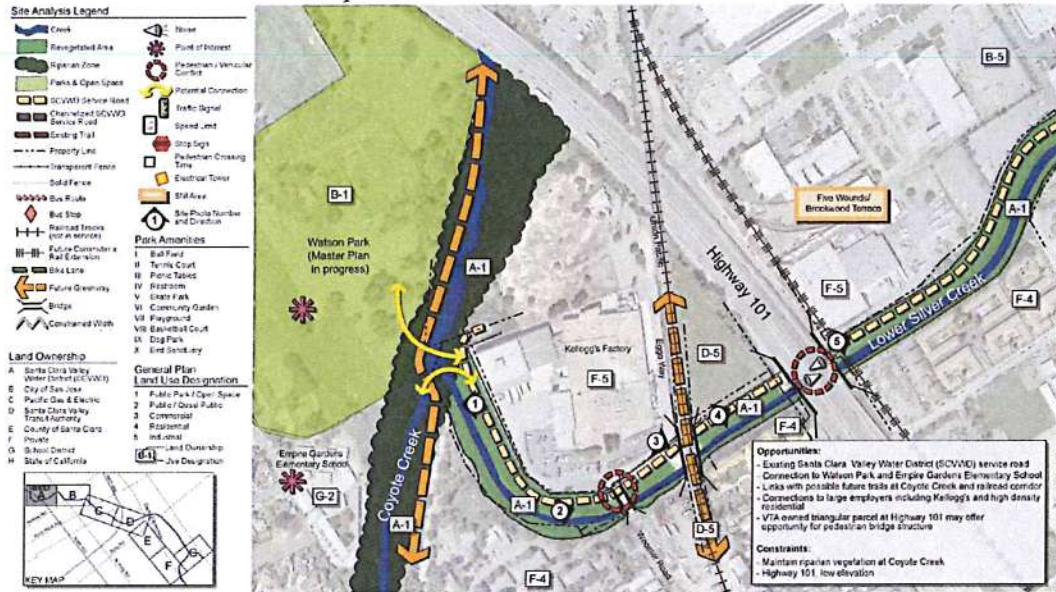
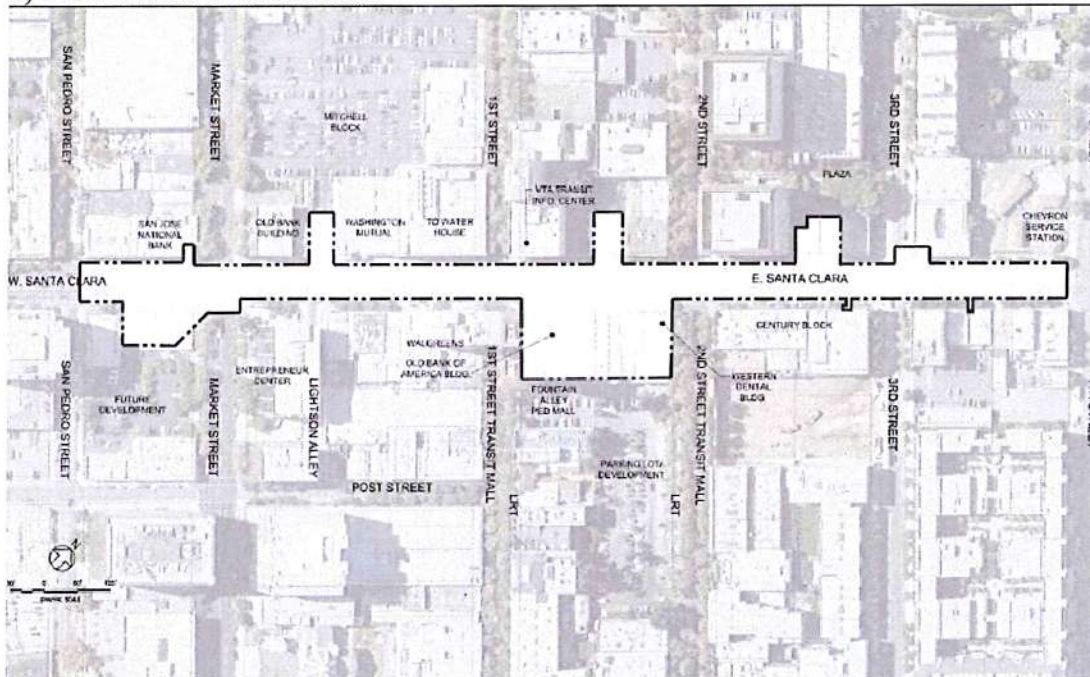

Figure B-42

I would like to confirm that the only known station alignment that does not conflict with the December 2007 environmental clearance for the Lower Silver Creek Trail (<http://www.sanjoseca.gov/DocumentCenter/View/9361>) is the diagonal between 28th Street and 101 with a tunnel portal east of 101



3) Civic Plaza/Market stations



It is generally agreed that the two stations should be combined into a single station but this would entail a 1,700-foot cut and cover trench under Santa Clara Street, including crossovers. I would like to spend some time discussing the relative merits of an alternate method of construction, specifically the Bond Street Crossrail station in Central London.

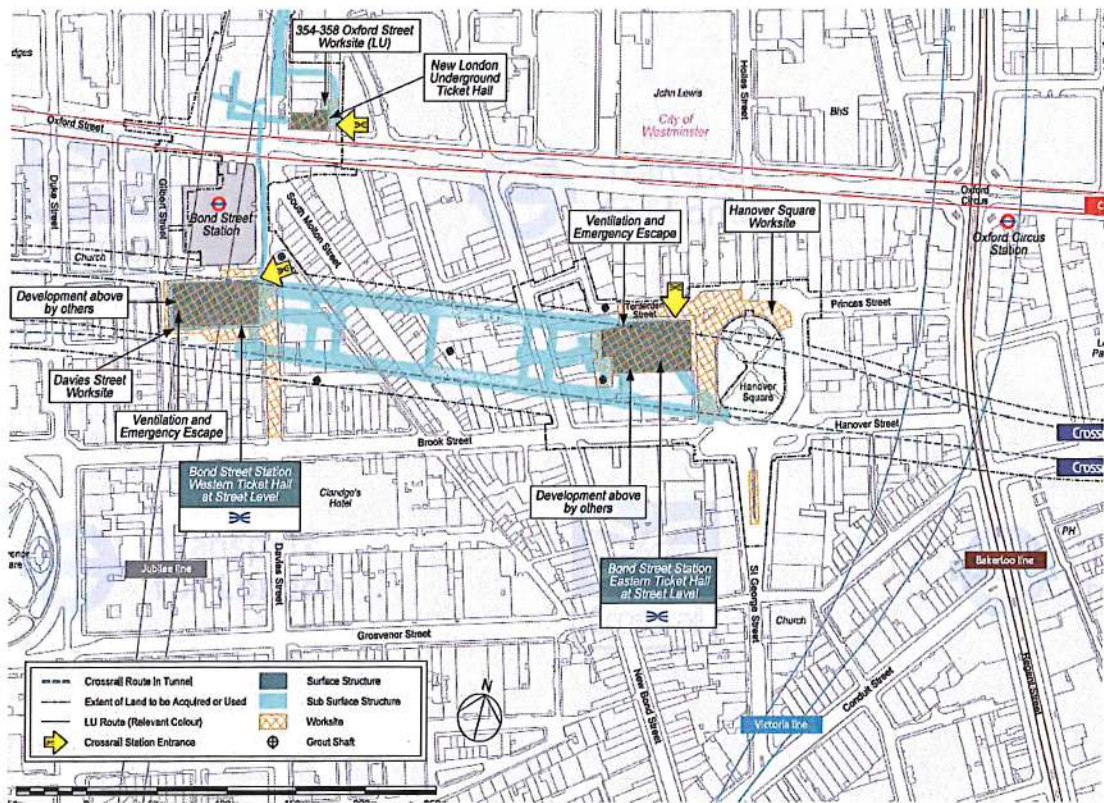
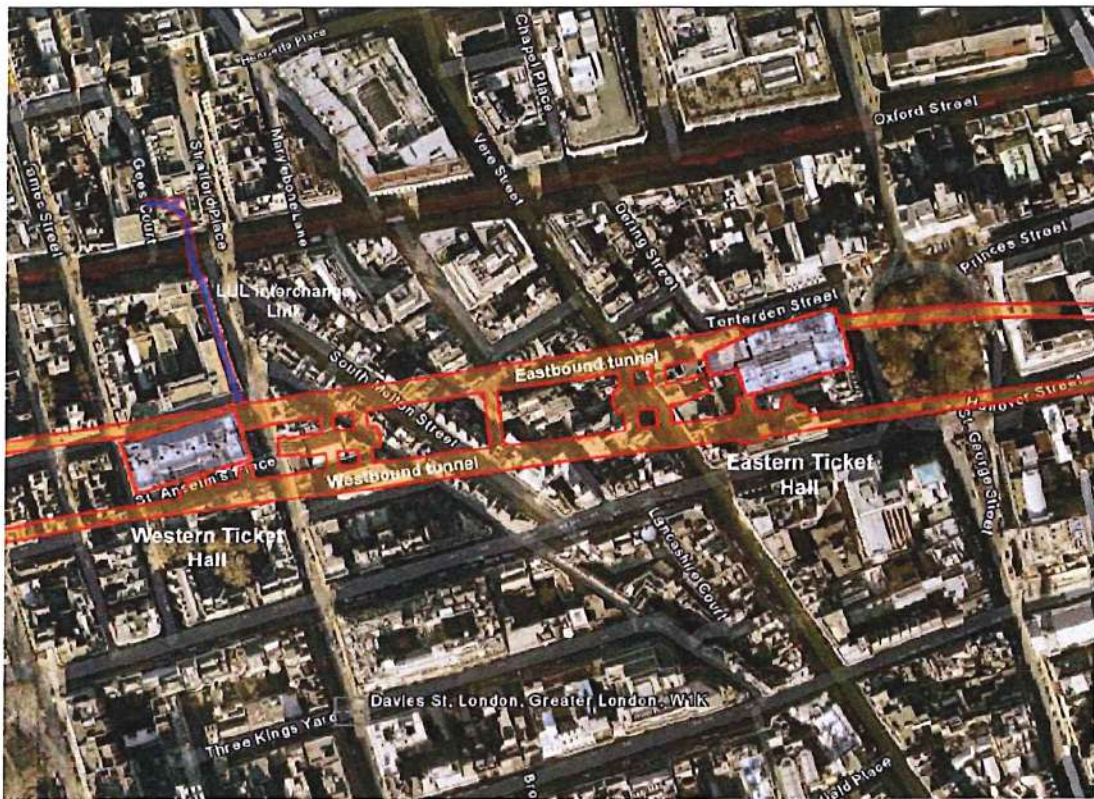

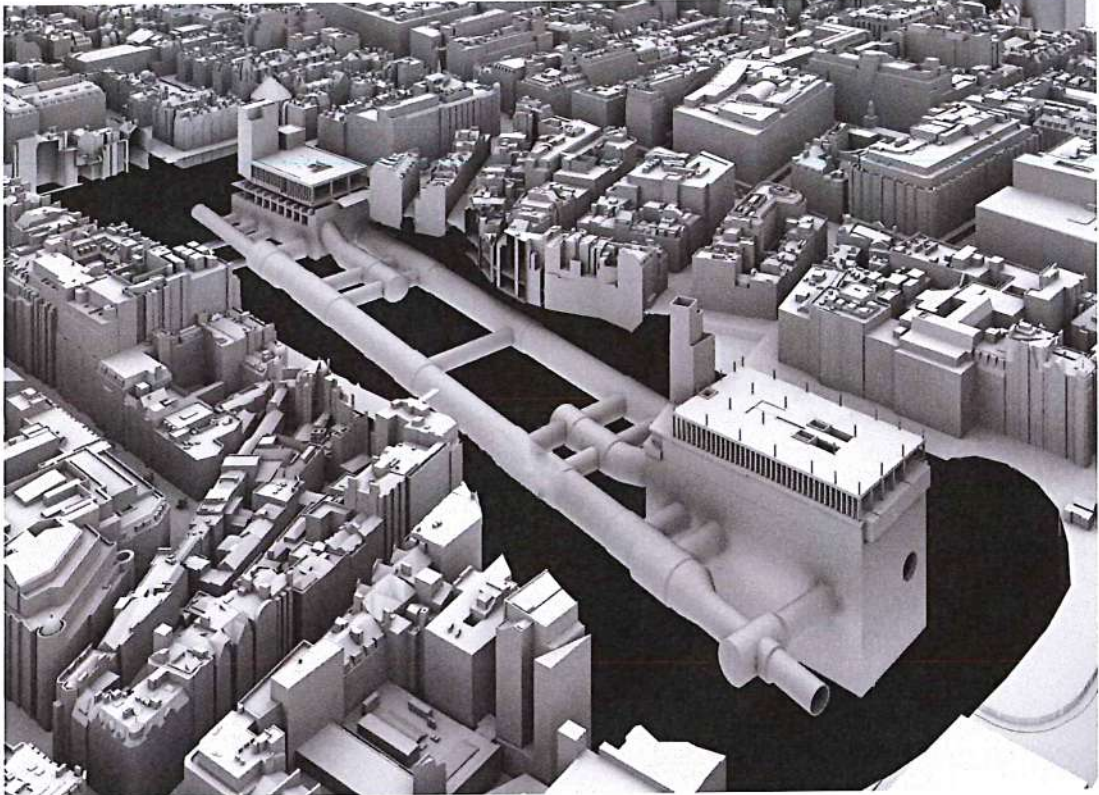

Downtown San Jose station



4) Diridon Station

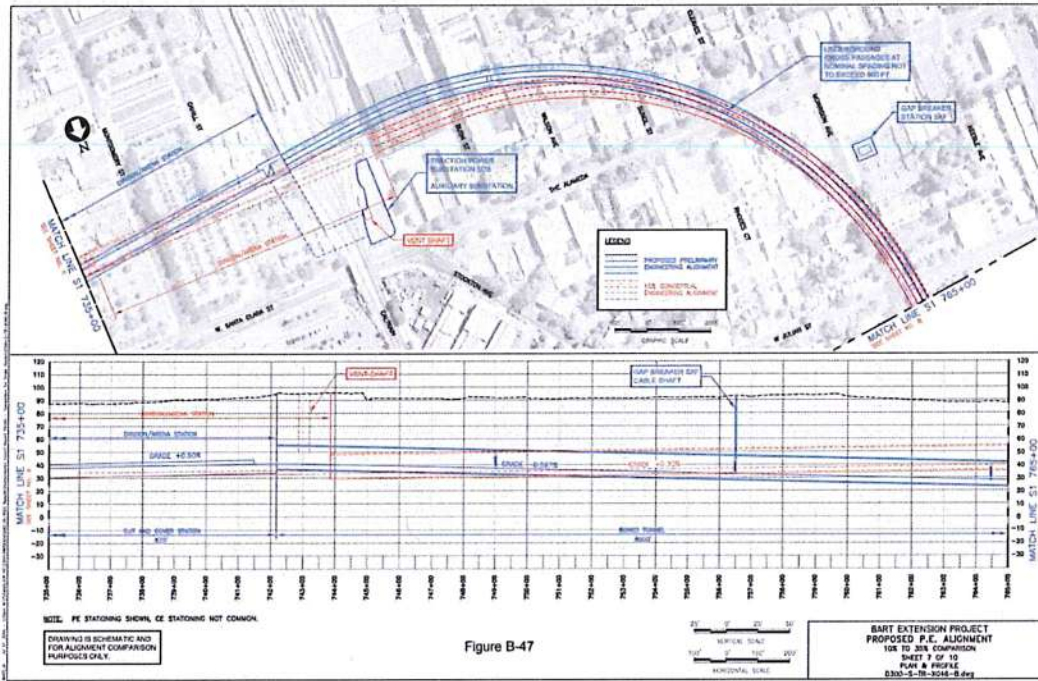

Figure B-47

I would like to discuss the following issues:

- Restoring the original BART station box alignment parallel to Santa Clara Street
- Relocating the parking structure to the other side of Santa Clara to act as a buffer for the transit center pedestrian core



- Addressing capacity issues similar to those at Montgomery/Embarcadero by replacing the Diridon BART central platform with 2 central tracks separating east and westbound outer platforms instead of adding outer tunnels at a cost of \$900M at a later date:

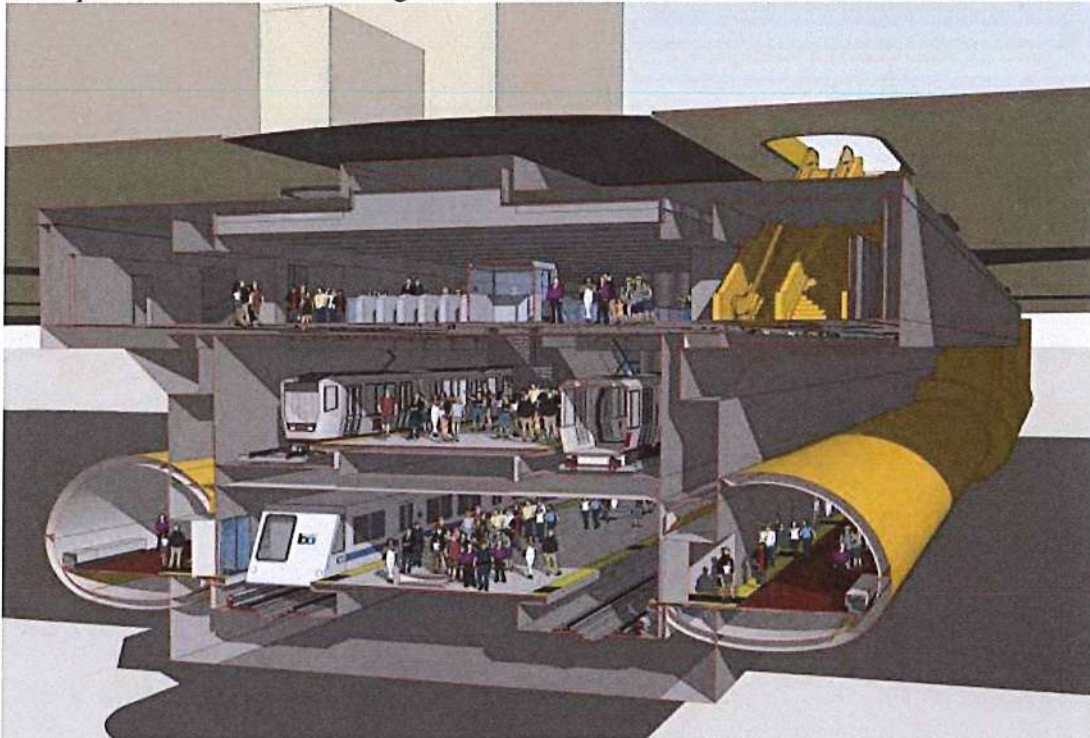

- Potentially relocating the VTA light rail station above the BART station box
- Lay the foundations for an underground High Speed Rail station

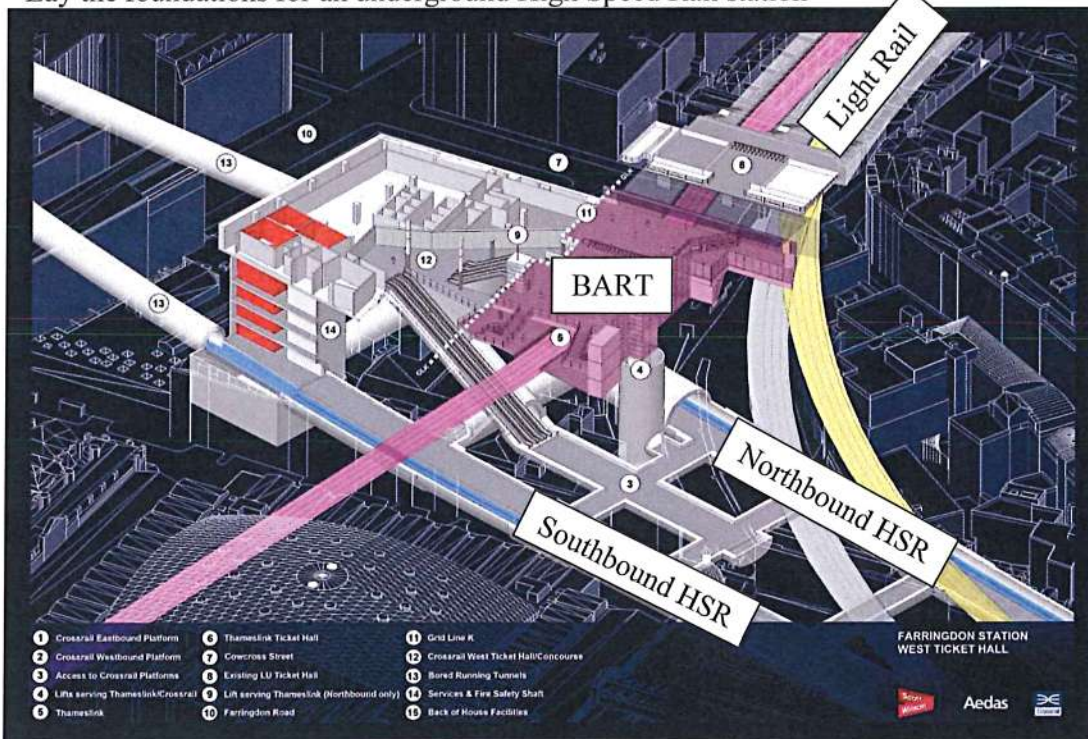

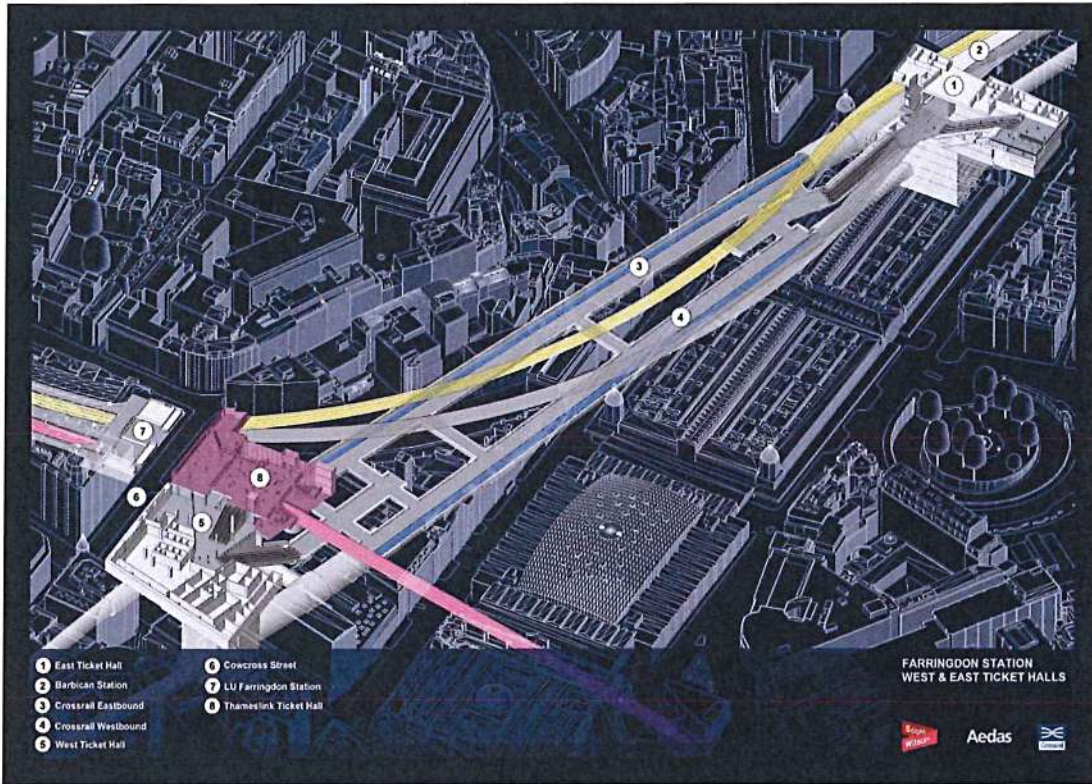

5) Costs

I would like to review the following:

- Breakdown of \$543M Phase I Professional Services
 - . By Subject Matter Expertise
 - . By Firm
- Breakdown of \$163M Phase II costs incurred to date
 - . By Subject Matter Expertise
 - . By Firm
- Breakdown of the cost estimate for the BART extension beyond Diridon, including tunnels and the Santa Clara storage yard vs. cost of Tamien<->Alviso ACE rail shuttles
- Cost impacts of increasing tunnel diameters from 17 feet 10 inches to 20 feet (same diameter as the Central Subway tunnels in San Francisco)

Thank you and I look forward to our meeting on the 19th of November

Sincerely,

Roland Lebrun.

Bond Street Site Plan

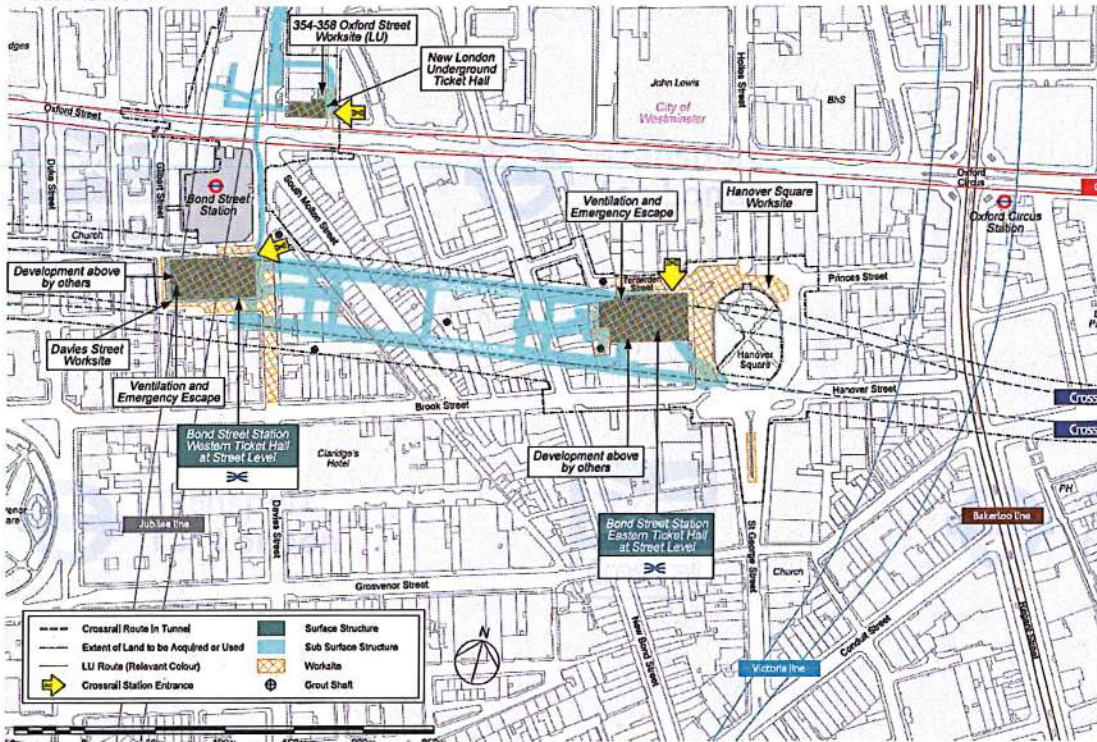

Aerial View

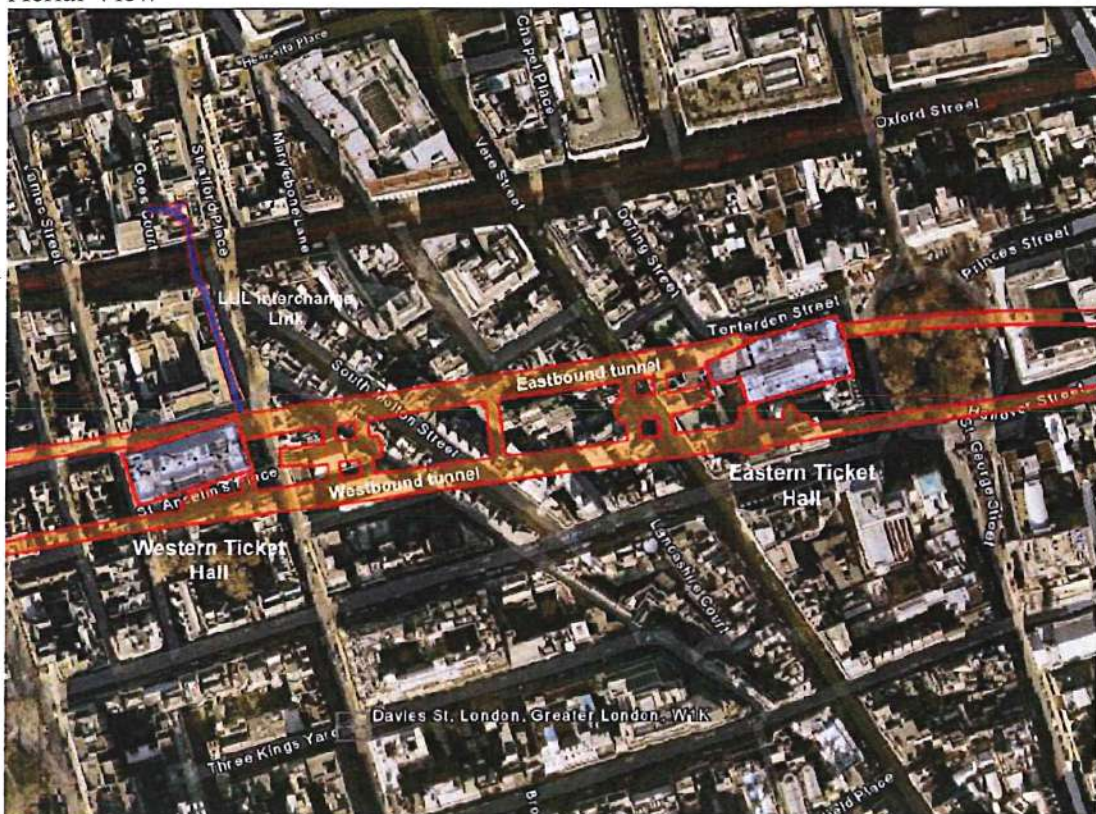

Western ticket Hall under construction



Eastern ticket hall under construction



3-D cutout including ground floor ticket halls before oversite development.

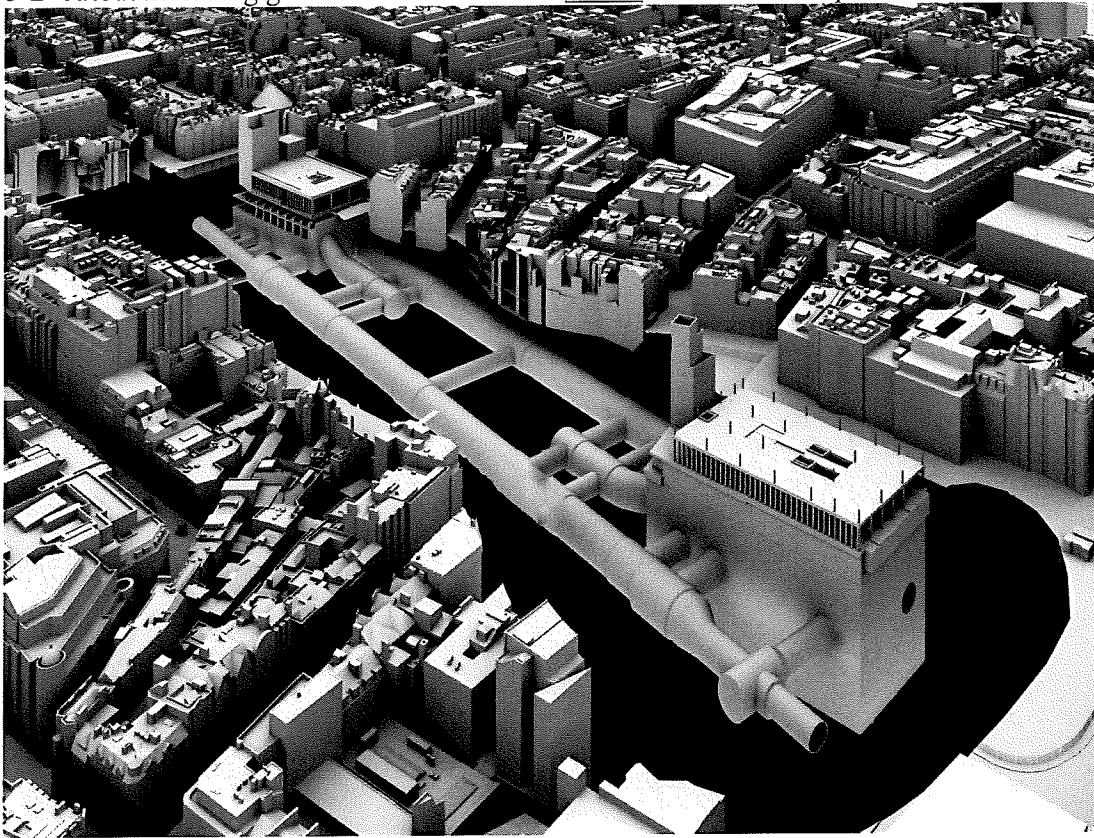

Eastern portal with oversight development



Western Portal with oversight development



Eastern ticket hall



Western ticket hall



Central circulation tunnel at the bottom of the escalator.
Northbound platform is on the right; Southbound platform is on the left.



Northbound Platform. Trains are on the right (behind the screen doors).
The eastern portal is at the other end of the platform.



1.2 Downtown

The SEIR should consider an alternate (mined) design similar to London's Bond Street Crossrail station which would enhance transfers with VTA light rail and buses, City Hall, the MLK library and San Jose State via separate train boxes located East of First Street and West of 4th Street.

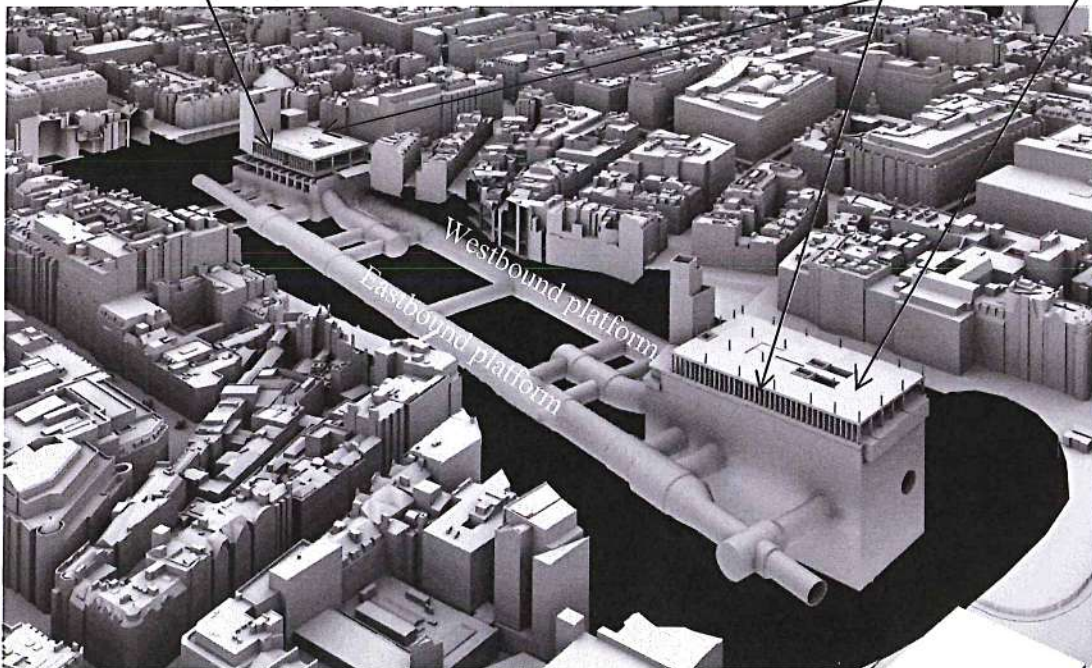
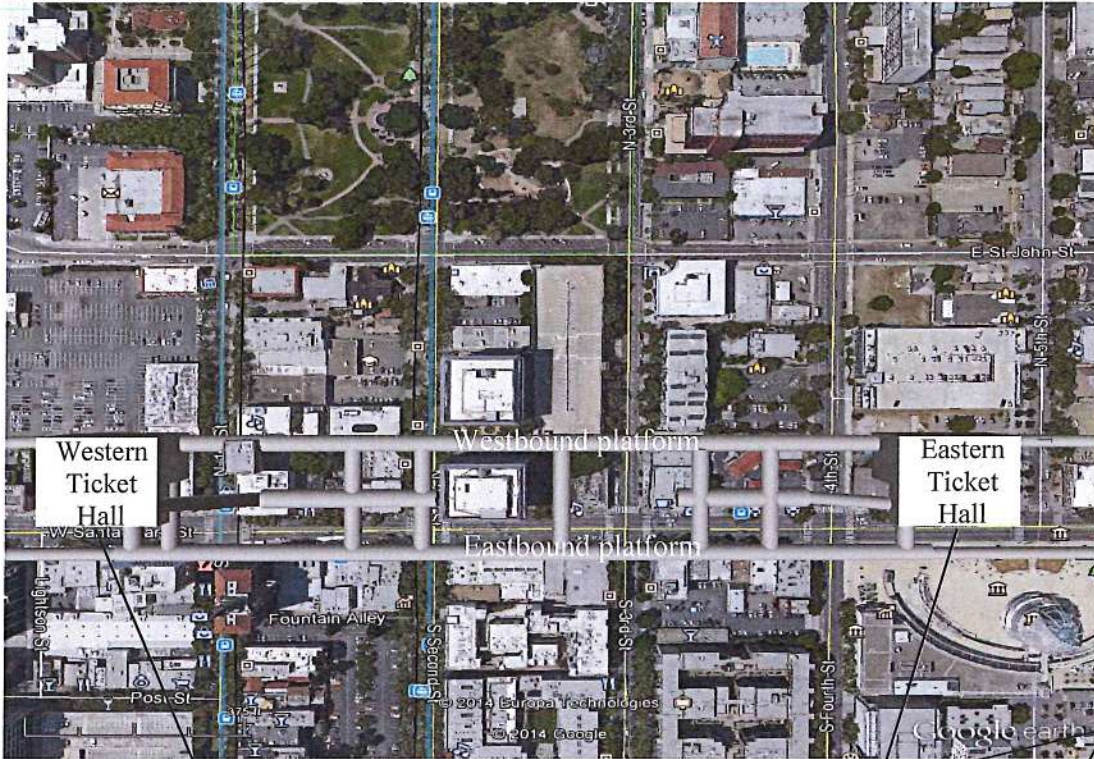

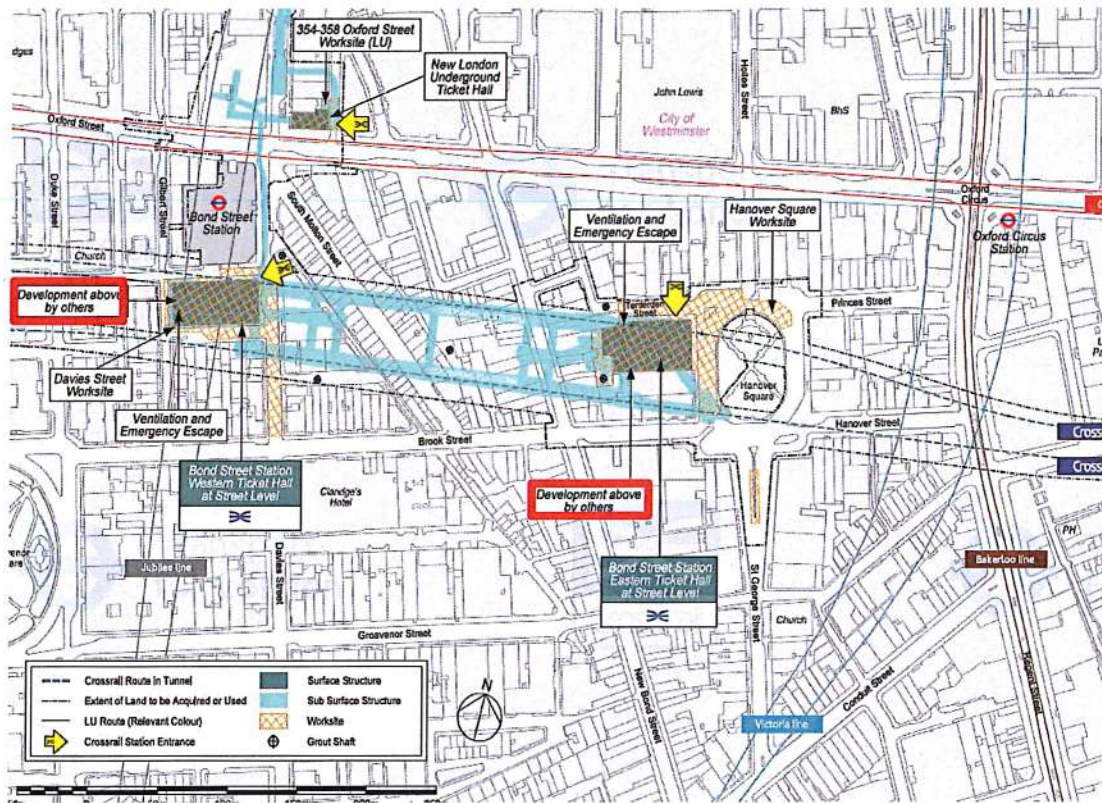

- The SEIR should fully consider the economic and socio-economic construction impacts of a downtown cut & cover station under East Santa Clara
- The SEIR should not consider any additional parking in the immediate vicinity of the Downtown BART station
- The SEIR should consider deterrents to discourage BART riders from driving to the Downtown station as well as incentives to use public transit alternatives, including driving to other BART stations.